

4800006

Models 480, 481

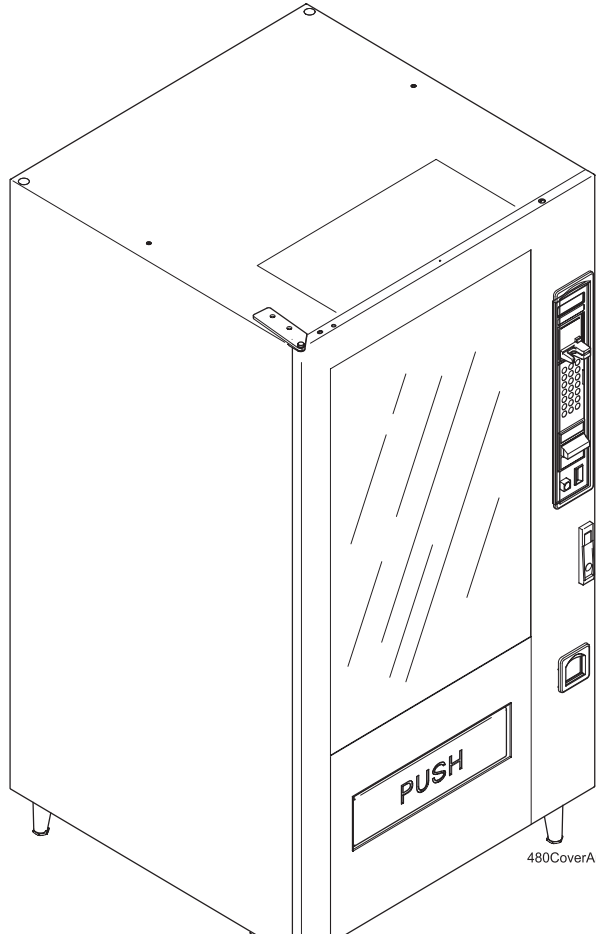

Refreshment Center 1



Operators' Guide

CRANE MERCHANDISING SYSTEMS™ A Crane Co. Company
GPL

12955 Enterprise Way
Bridgeton, Missouri 63044-1200
(314) 298-3500
www.CraneMS.com

Copyright© 12-04

4800006

TABLE OF CONTENTS

Introduction	1
Power Requirements	3
Unpack the Machine	3
Controls and Indicators	4
Turn the Merchandiser ON and OFF	6
Initial Set-Up	7
Moving the Merchandiser Through a Narrow Doorway	7
Open the Rear Outlet Diffuser	9
Position the Merchandiser	9
Configure Machine for Dual Zone.....	10
Tray Set-Up	17
Place a Tray in the Loading Position	17
Set up Trays to Vend Products	18
Set Up A Tray To Vend Wide Products	18
Remove a Snack or Candy Tray	19
Remove a Bottle Tray	21
Remove and Install Column Dividers.....	22
Operate a Tray Outside of the Machine.....	22
Replace a Motor with a Spiral Bearing.....	23
Connect and Disconnect a Motor Harness.....	24
Remove and Install Spirals	25
Remove a Spiral Coupler.....	26
Remove and Install a Spiral Motor.....	27
Install a Gear	28
Install a Spiral Coupler	29
Move a Tray Up or Down.....	30
Install a Tray in the Merchandiser	31
Install and Remove a Product Spacer	32
Load the Merchandiser	33
General Tray Loading:	33
Special Considerations:.....	33
Spiral Wall Retainer Usage.....	34
Product Pusher Usage	35
Configure the Merchandiser to vend "Lunch Buckets"	35
Configure the Merchandiser for Vending "Top Shelf"	36
Return the Trays to the Vending Position.....	37
Install and Set Price Labels.....	38
SureVend™	41
Health Control	42
Final Installation	44
Level the Merchandiser	44
Install the Base Plate.....	45
Install the Lock Cylinder	46

Install the Optional Cash Box Lock.....	46
Set Up the Coin Mechanism	47
Load the Coin Mechanism.....	47
Operational Readiness Check	48
Spiral Indexing Procedure (One Spiral, One Motor)	48
Spiral Indexing Procedure (Two Spirals, One Or Two Motors).....	49
Test the Bill Validator.....	49
Programming Intro	50
The Displays	50
The Function Keys.....	51
Other Keys	51
Control Panel Switches Explained.....	52
Programming Flow Charts	53
Programming Procedures.....	55
Enter a New Supervisor Code	55
Enter a Freevend Code	55
Lock Or Unlock Mode Or Payout Keys	56
Turn Talker Mode On or Off	56
Set DEX Options	57
Select Display Language	58
Select Coin Mechanism	58
Select Card Reader and Options	60
Set Temperature	64
Enable or Disable Trays	65
Set SureVendUp the SureVend Anti-Jackpot Feature	66
Set first in - first out(fifo) mode	68
Show the Temperature in Standby Mode	69
View Surevend Software version	70
View Software Version	70
Set the Date	71
Set Daylight Savings Option	71
Set Time-Of-Day Free Vending	72
Set Time-Of-Day Discount Vending	72
Time Interval Editing	72
Select a Standby Message	74
Select a Freevend Message	75
Set Prices	78
View Sales Data Three Different Ways	79
View Card Reader Paid Sales	79
View Total Paid Vends	80
Clear All Resettable Data	80
View Amount In Coin Box	81
View Amount In Validator	81
View Discount Sales By Time Interval	82
View Free Vends	82
View Time Data.....	83
View Total Unpaid Vends	85

View Number Of Test Vends 85
View Machine ID Number 85
Test the Motors 87
Download Data To A PDCD 90
Set Freevend Options 90

Section 1: Introduction

Exterior View

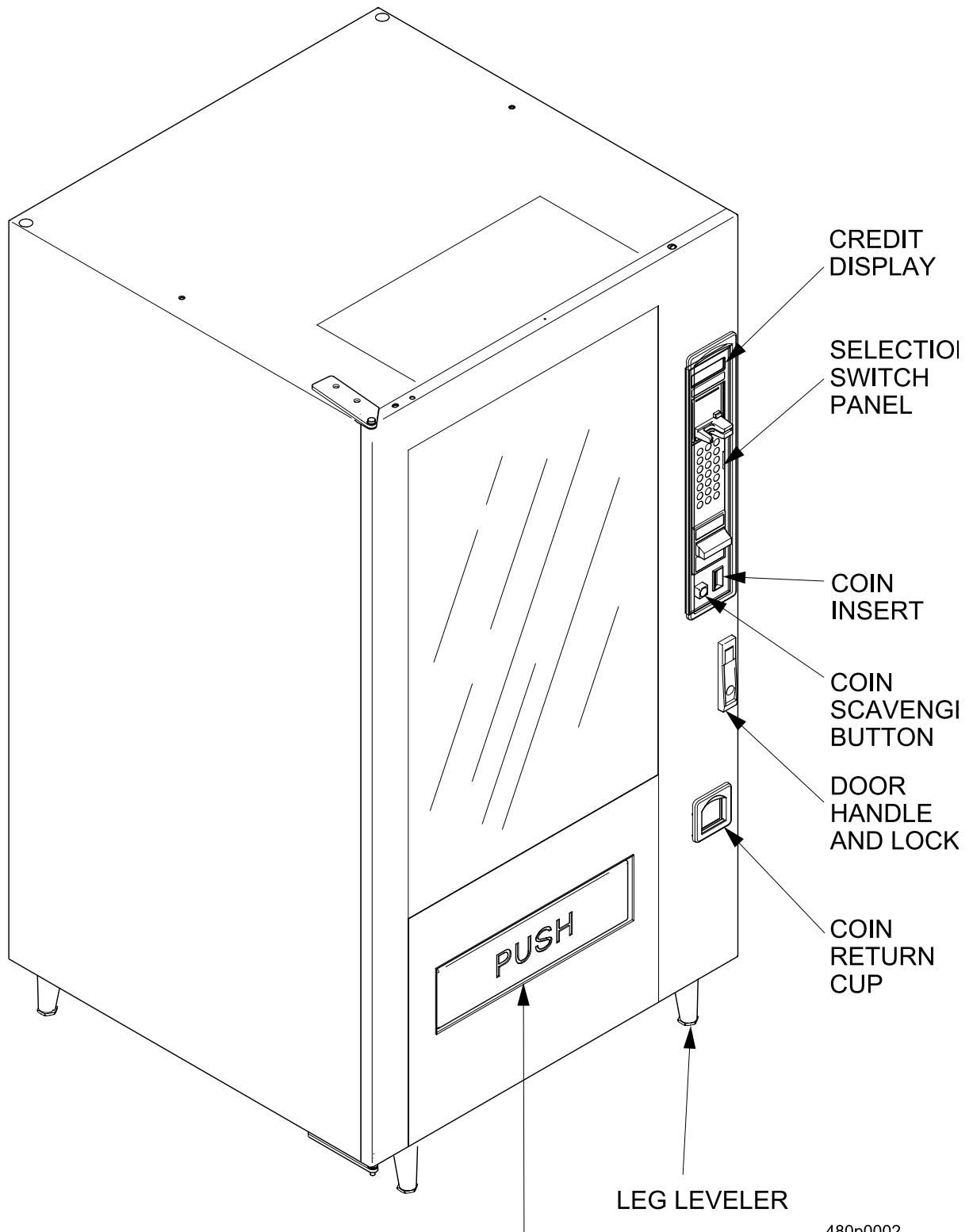

Interior View

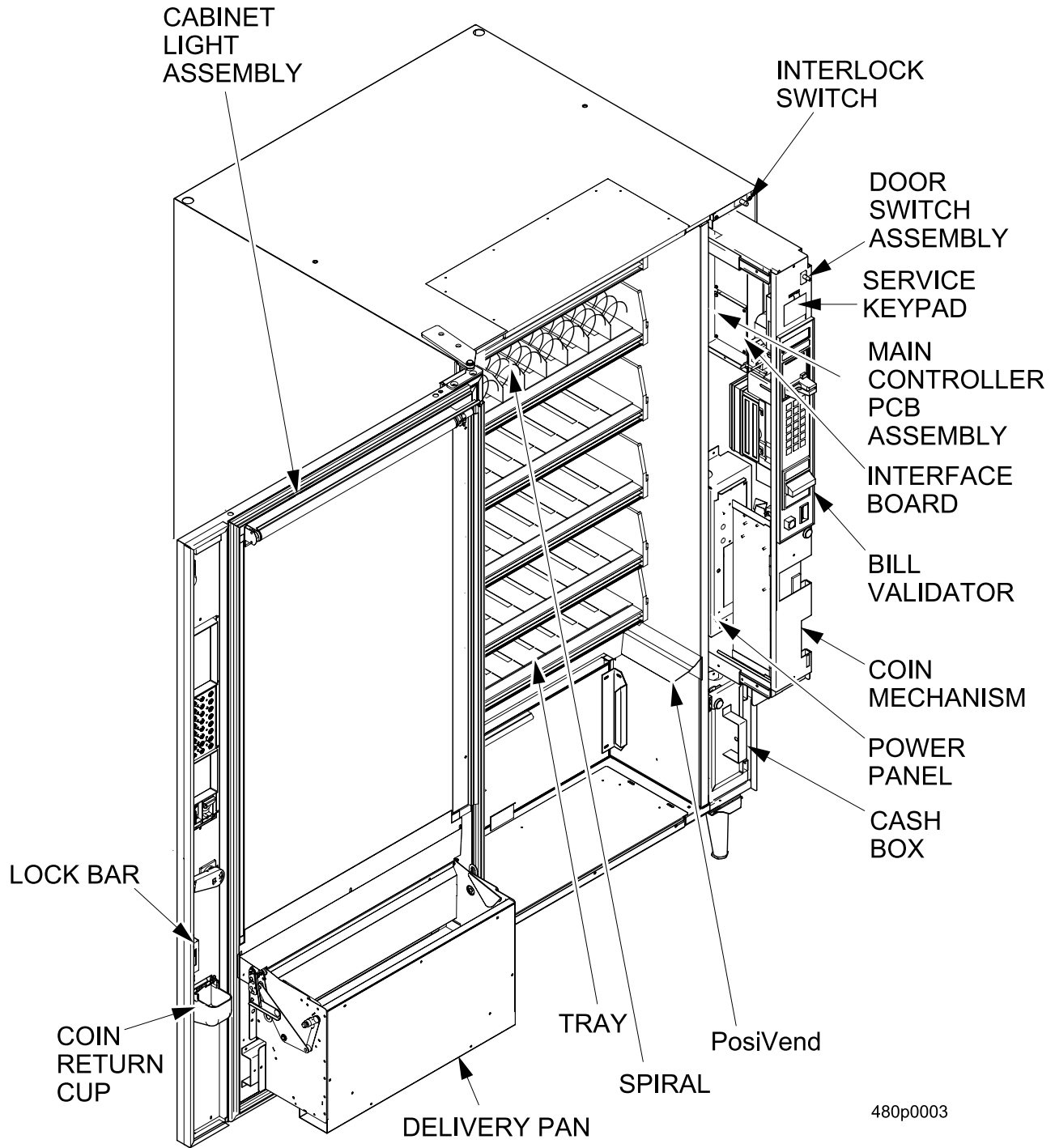

Power Requirements

The merchandiser is supplied with a service cord for the country of use and is terminated in a grounding type plug. The wall receptacle used for this merchandiser must be properly polarized, grounded, and of the correct voltage. Operating the merchandiser from a source of low voltage will **VOID YOUR WARRANTY**. Each merchandiser should have its own electrical circuit and that circuit should be protected with a circuit breaker or fuse conforming to local regulations.

1. **Voltage Check** - Place the leads of a voltmeter across the LINE (LIVE) and NEUTRAL terminals of the wall receptacle. The voltmeter should indicate 110-130 volts AC for 120 volt, 60 Hz locations, or 220- 240 volts AC for 230 volt, 50 Hz locations.
2. **Polarity Check** - Place the leads of a voltmeter across the LINE (LIVE) and GROUND terminals of the wall receptacle. The voltmeter should indicate 110-130 volts AC for 120 volt, 60 Hz locations, or 220- 240 volts AC for 230 volt, 50 Hz locations.
3. **Noise Potential Check** - Place the test leads of a voltmeter across the NEUTRAL and GROUND terminals of the wall receptacle. The meter should indicate 0 volts AC. A measurement greater than 1.5 - 2.0 volts AC could result in problems for the merchandiser's electronic circuitry caused by electrical noise.

Any deviation from these requirements could result in unreliable performance from your merchandiser.

Unpack the Machine

Remove all packing materials from the interior of the machine. Keep all documents; warranty cards, etc. Set aside the base plate kit (if present).

Controls and Indicators

DOOR SWITCH. When the cabinet door is open, this switch turns off the compressor and evaporator fan.

INTERLOCK SWITCH. (230 volt models only) Turns off the glass heater and display lights when the cabinet door is open. Pull the switch out to restore high voltage for maintenance.

LOW VOLTAGE SWITCH. Tells the controller software the main door is open or closed.

MESSAGE DISPLAY. This is how the merchandiser communicates with the outside world. Customers can see messages about how much money they have put into the merchandiser. The message display also tells customers when a selection is sold out and when vending is free, inhibited, or discounted. The message display shows you what you are doing when you program the merchandiser, and can show you what is wrong if there is a failure.

FREE VEND KEYSWITCH (OPTIONAL). This allows someone (other than maintenance personnel) to set the merchandiser to free vend without opening the door.

SELECTION KEYPAD. The customer uses this keypad to make selections. Maintenance people may use this keypad during programming.

COIN RETURN BUTTON. Returns any coins paid into the merchandiser prior to a vend.

BILL ACCEPTOR (OPTIONAL). Accepts bills of various denominations, depending upon the type of bill validator, and how the machine is configured.

SERVICE KEYPAD. The service keypad is located at the top of the monetary panel. It gives service personnel the means to program, retrieve data from, and view diagnostic information about, the merchandiser.

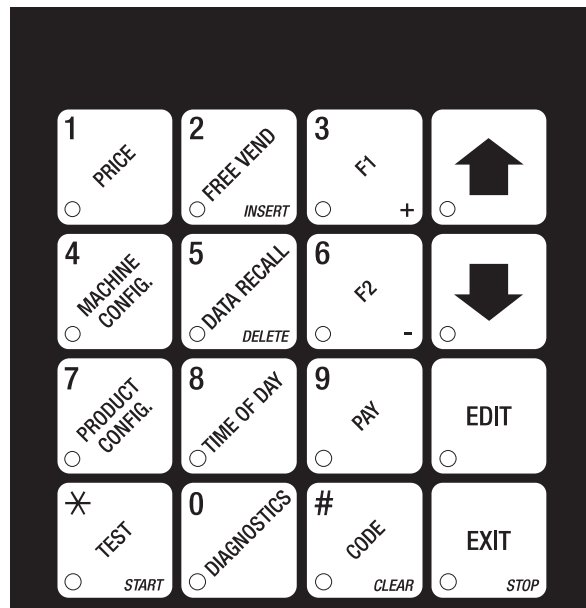
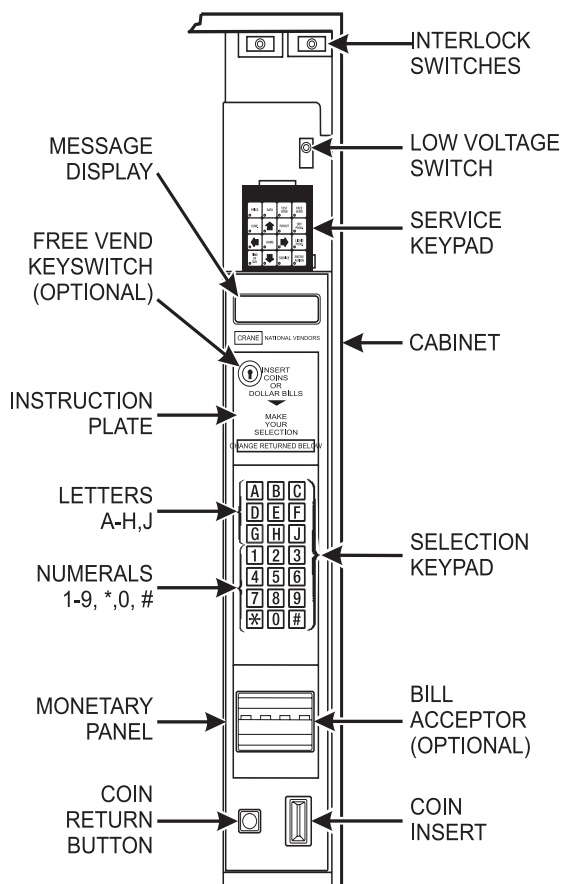

MAIN CONTROLLER PCB DISPLAY. This display consists of two light emitting diodes (LED) mounted on the controller PCB.

- POWER ON (LED 1)** When lit, this red LED indicates electrical power is applied to the controller PCB.
- HEARTBEAT (LED 2)** When flashing, this red LED indicates that the controller PCB is active, and the software is operating.

"CAUTION - Risk of explosion if battery is replaced with an incorrect type. Dispose of used batteries according to the manufacturer's instructions."

NORMAL CONDITIONS:

When the merchandiser is operating normally, you should see a steady red **POWER ON** indicator and a flashing red **HEARTBEAT** indicator. Contact a service representative if any other condition exists.

Back Side of U.S./Canada Power Panel. The circuit board mounted on the rear of the power panel is a DC power supply for the coin mechanism. A fuse protects the board circuitry in the event of a coin mechanism solenoid failure. If the coin mechanism is not working, check this fuse. If the fuse is blown, a bad coin mechanism solenoid could be at fault.

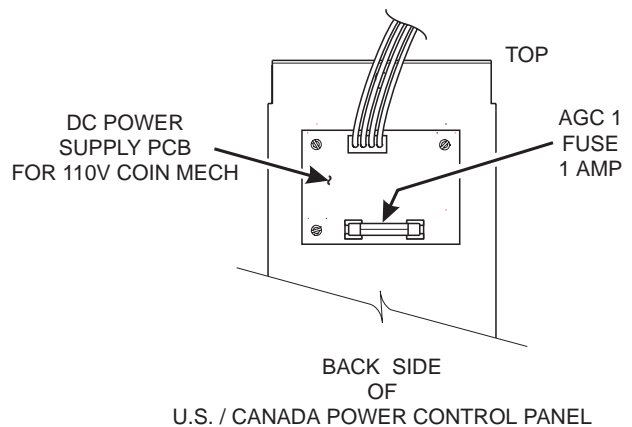

Turn the Merchandiser ON and OFF

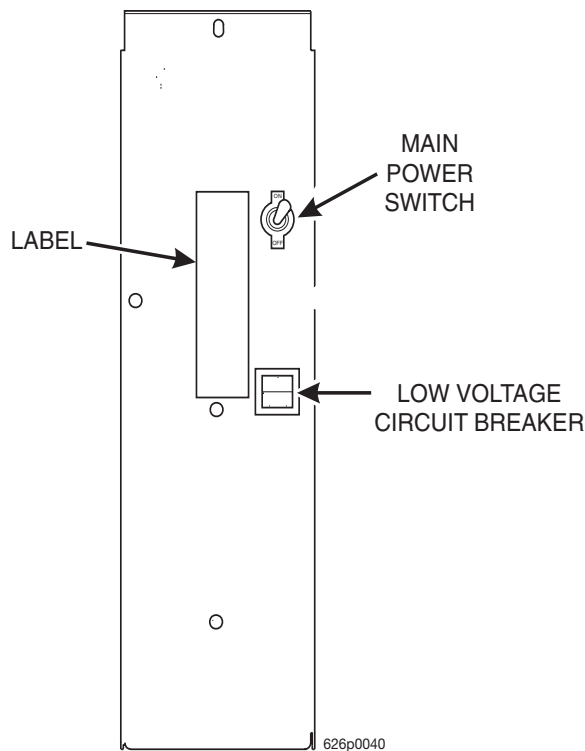

US / CANADA POWER PANEL

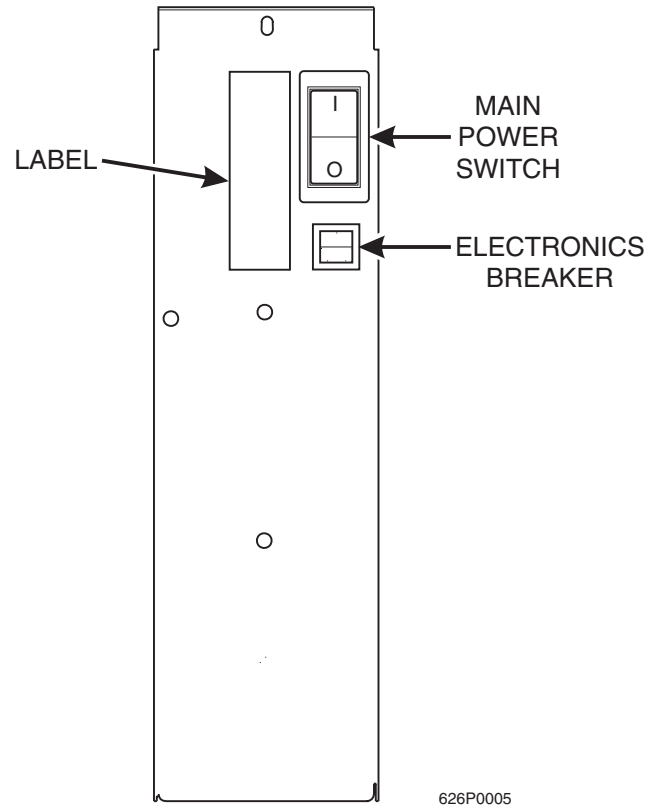

INTERNATIONAL POWER PANEL

- Power to the merchandiser is controlled by the main power switch, located on the power panel.
- The power panel is on the right side of the merchandiser, behind the monetary panel.

WARNING

Lethal voltages are present. Unplug the merchandiser before you perform any of the following tasks:

- Change a fuse
- Change the fluorescent lamp
- Change the lamp starter
- Connect or disconnect a harness (except a motor harness when the tray has been removed)

Failure to do so may result in personal injury.

Section 2: Initial Set-Up

Moving the Merchandiser Through a Narrow Doorway

NOTE

If necessary, this merchandiser can be moved through an opening as narrow as 30 inches by removing panels at the top and bottom of the cabinet.

Remove the Bottom and Top Panels:

1. Remove the screws that secure the top and bottom knock-out panels to the cabinet.
2. Lift panels upward to remove them from the cabinet.

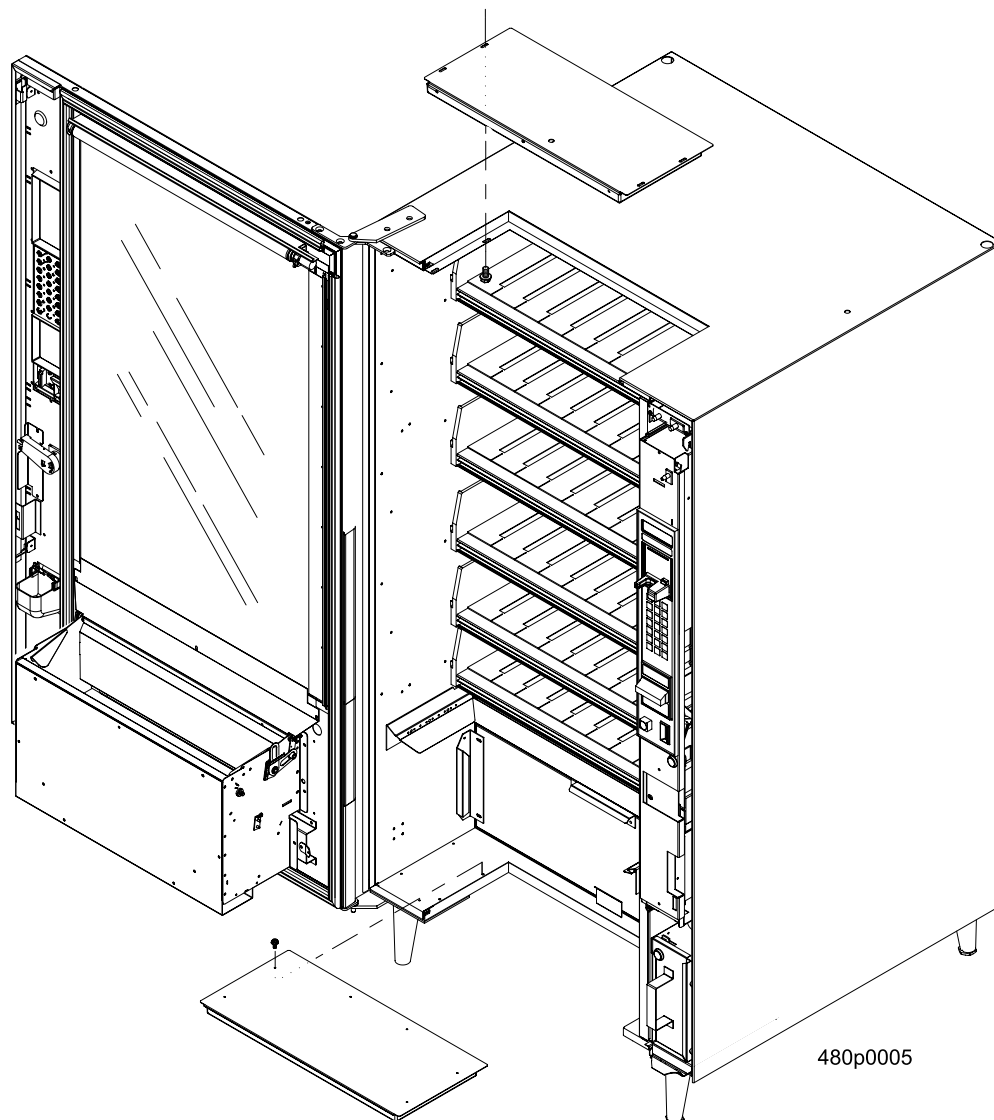

Move the Merchandiser through the Opening:

1. Open the cabinet door and place it square with the left side of the cabinet.
2. Carefully walk the merchandiser through the opening.

Reassemble the Merchandiser:

1. Replace the upper and lower panels.

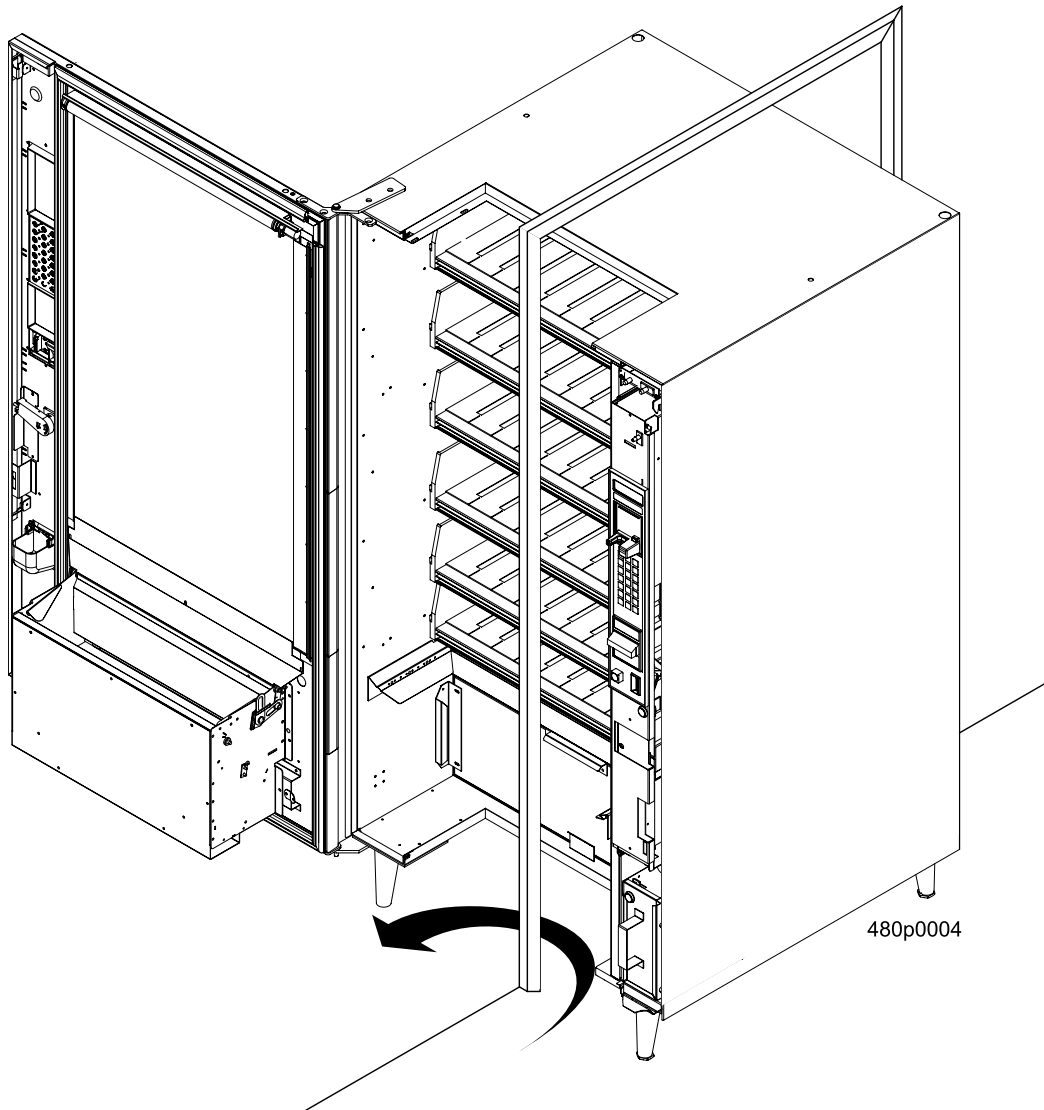

Open the Rear Outlet Diffuser

The rear outlet diffuser vents warm air up and out of the back of the merchandiser, away from the air inlet (on the bottom of the cabinet). It is shipped in the closed position and **must** be opened before the merchandiser is put into service.

1. Remove the two screws holding the upper corners of the diffuser against the back of the cabinet. Notice the two unused screw holes at the corners.

NOTE:

Wear protective gloves when bending diffuser to prevent injury.

2. Pull the top of the diffuser away from the cabinet, then bend the diffuser so that the unused screw holes align with the holes in the cabinet.
3. Use the two screws removed in step one to affix the diffuser to the cabinet in its new "open" position.

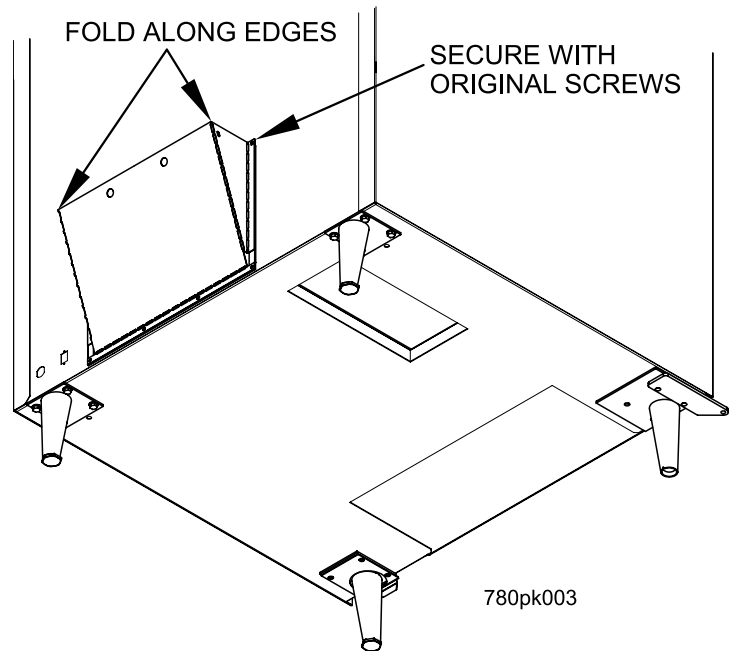

CAUTION

The merchandiser will not function properly if the Rear Outlet Diffuser is not open!

Position the Merchandiser

Move the merchandiser to its **approximate position**. There are certain procedures you need to perform before it is in its permanent location. Plug in your merchandiser and turn the power switch to **ON**.

- You can position this merchandiser anywhere in a bank of machines. It can even be placed on an end flush against a side wall.
- The merchandiser should be placed at least four inches away from the back wall (six inches if rear diffuser is not installed). This will provide adequate air circulation for the refrigeration unit. This will provide adequate air circulation for the refrigeration unit.
- The merchandiser will operate more efficiently when placed in a shaded location.
- There should be enough room in front of the merchandiser for the door to move freely.

CAUTION

This machine is only rated for installation at an indoor location.

Configure Machine for Dual Zone

To configure your machine for dual zone you must first know what duct system your machine has. There are two different duct systems. There is a version 1 duct system which uses a tall air supply panel (as shown in figure 1 and 2). This air supply panel will extend all the way to the top of the machine. Version 2 duct system which uses a short air supply panel (as shown in figure 3) will only extend about half way up the machine.

Both duct systems have two different configurations for the dual zone option. There is a two tray configuration and a three tray configuration.

If you have a version 1 duct system and you are configuring your machine for a two tray configuration: (See Figure , "Figure 1," on page 11)

If you have a version 1 duct system and you are configuring your machine for a three tray configuration: (See Figure , "Figure 2," on page 13)

If you have a version 2 duct system and you are configuring your machine for a two tray or a three tray configuration: (See Figure , "Figure 3," on page 15)

Note:

If you are not using dual zone in the merchandiser then you must remove the barrier, foam boards, air deflector, and the air plate.

The temperature sensor will be mounted on the top left hand side of the cabinet.

Set machine for two tray configuration version 1:

REMOVE PC BOARD FROM TRAY RAIL AND ATTACH TO THE POSTS ON LOWER RIGHT HAND RAIL

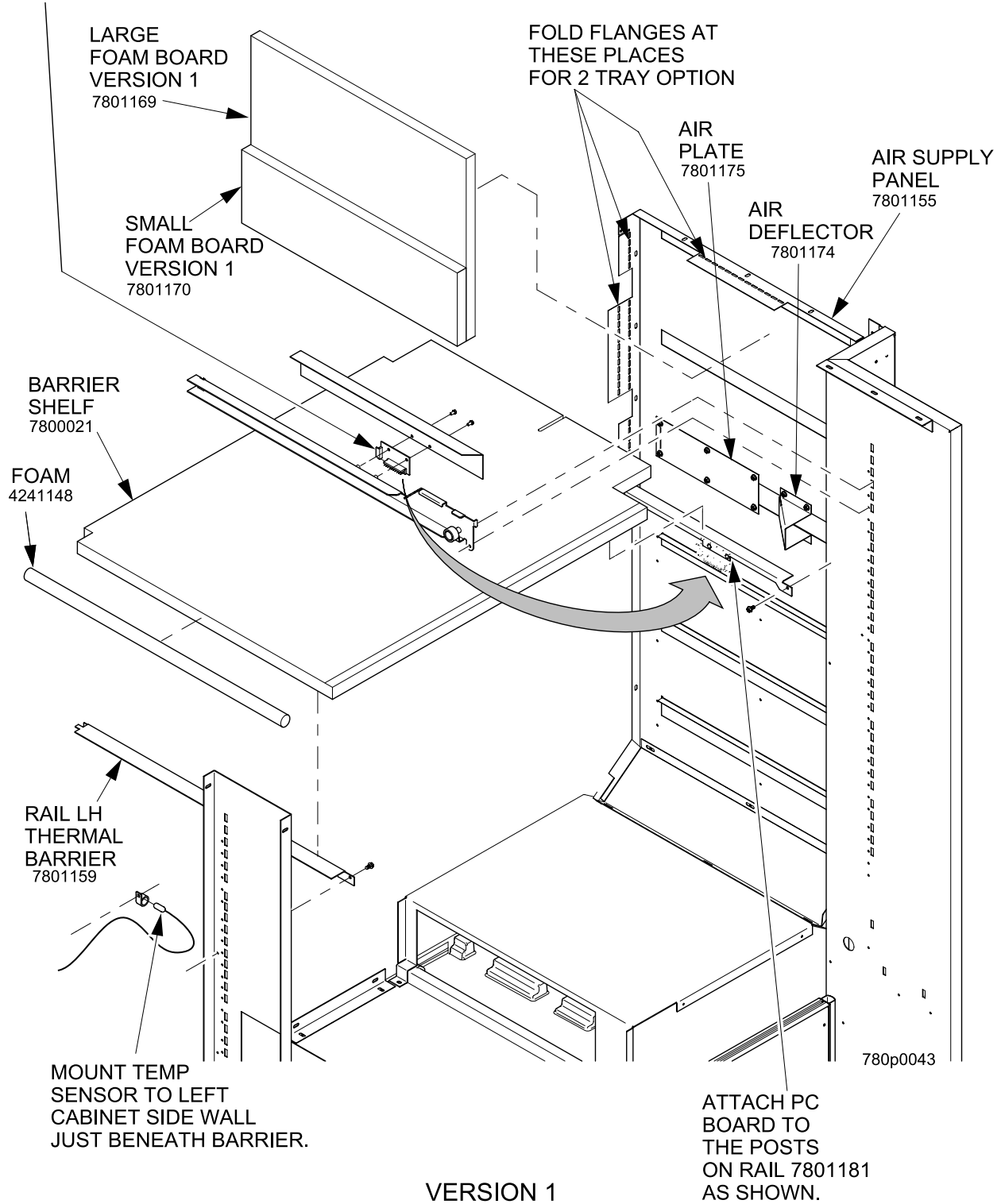

VERSION 1

FIGURE 1

**Version 1 duct system two tray configuration
(See Figure , "Figure 1," on page 11)**

1. You must first remove all trays from your merchandiser.
2. Remove the right tray rail guide for tray A shelf.
3. Remove the tray rail board and the tray shield from the second tray guide rail in the machine.
4. Re-attached the tray shield to the second tray rail.
5. Mount the tray rail board and the to the right side of the barriers mounting rail standoffs.
6. Remove the temperature sensor bracket mounted to the left hand side of the cabinet. Do not unplug the sensor, let it hang down the left hand side of the cabinets wall.
7. Position the barrier inside the cabinet just below the second trays rails. Make sure that the third tray rail connector plug is left underneath the barrier. You will need to remove the left hand side tray rails underneath the barrier in order to position the barrier.
8. Mount the barriers mounting rails to the sides of the machine using one screw for each rail.
9. Move the barrier to the back right corner of the cabinet leaving a gap on the left hand side of the barrier.
10. Place the 1/2" by 1/2" piece of foam tape on the left side of the cabinet in between the barrier and the cabinet where you have left the gap.
11. Place the large foam board at the upper right side of the air supply panel.
12. Place the small foam board next to the large foam. Make sure that the small board is at the bottom of the large board.
13. Bend the flanges on the air supply panel to hold the foam boards in place.
14. Mount the air plate directly under the barrier on the right side of the air supply panel.
15. Mount the air deflector in front of the air plate under the barrier. (The opening should be facing you.)
16. Re-mount all tray rails and re-connect all rail connections.
17. Replace all snack and candy trays. You may have to adjust the tray rails underneath the barrier to provide adequate spacing for your trays.
18. Re-mout the temperature probe underneath the barrier in the holes provided on the left inside wall of the cabinet.

Set the machine for three tray configuration version 1:

Note:

If you are using a three tray configuration you will not use the air deflector and the air plate.

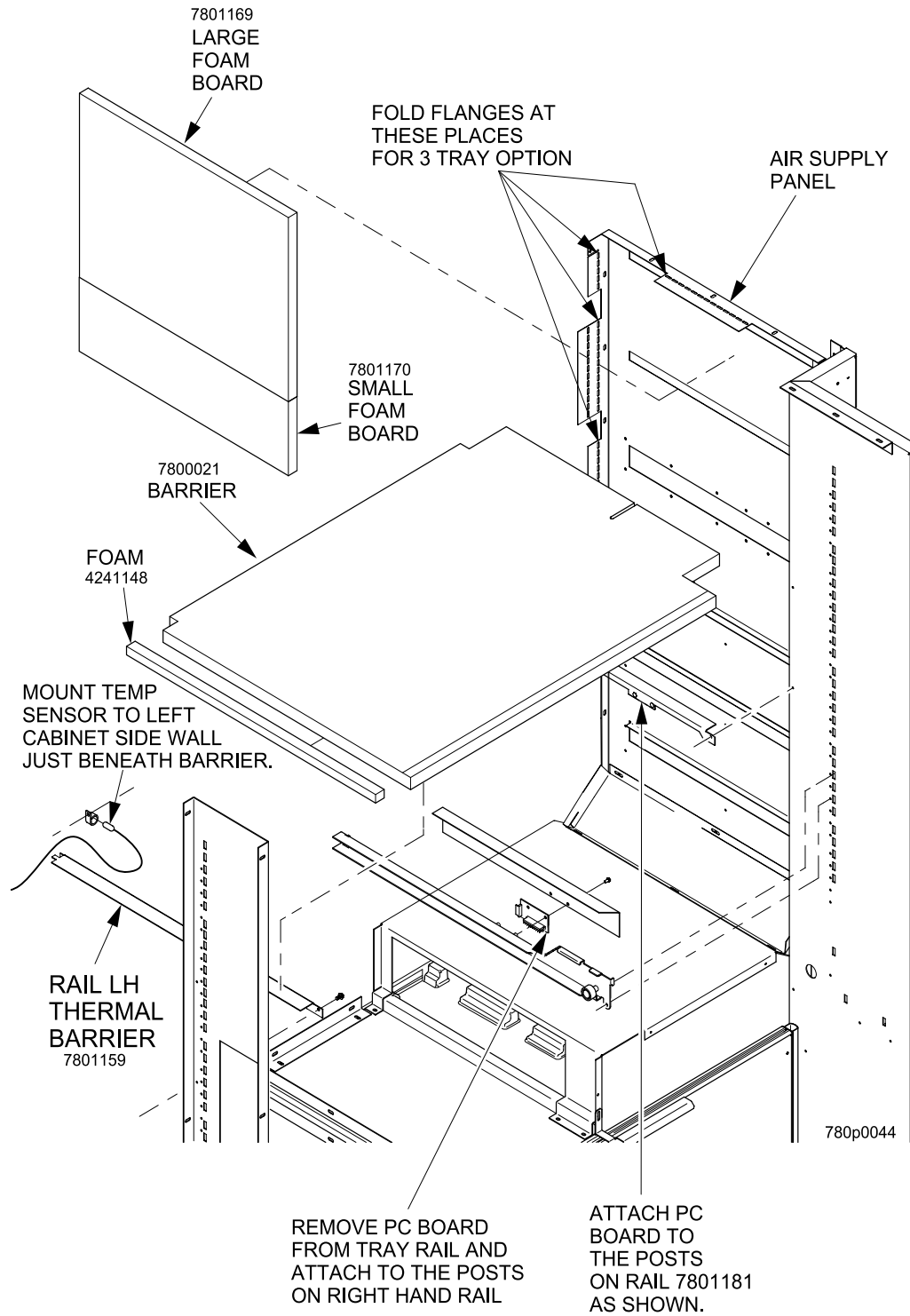
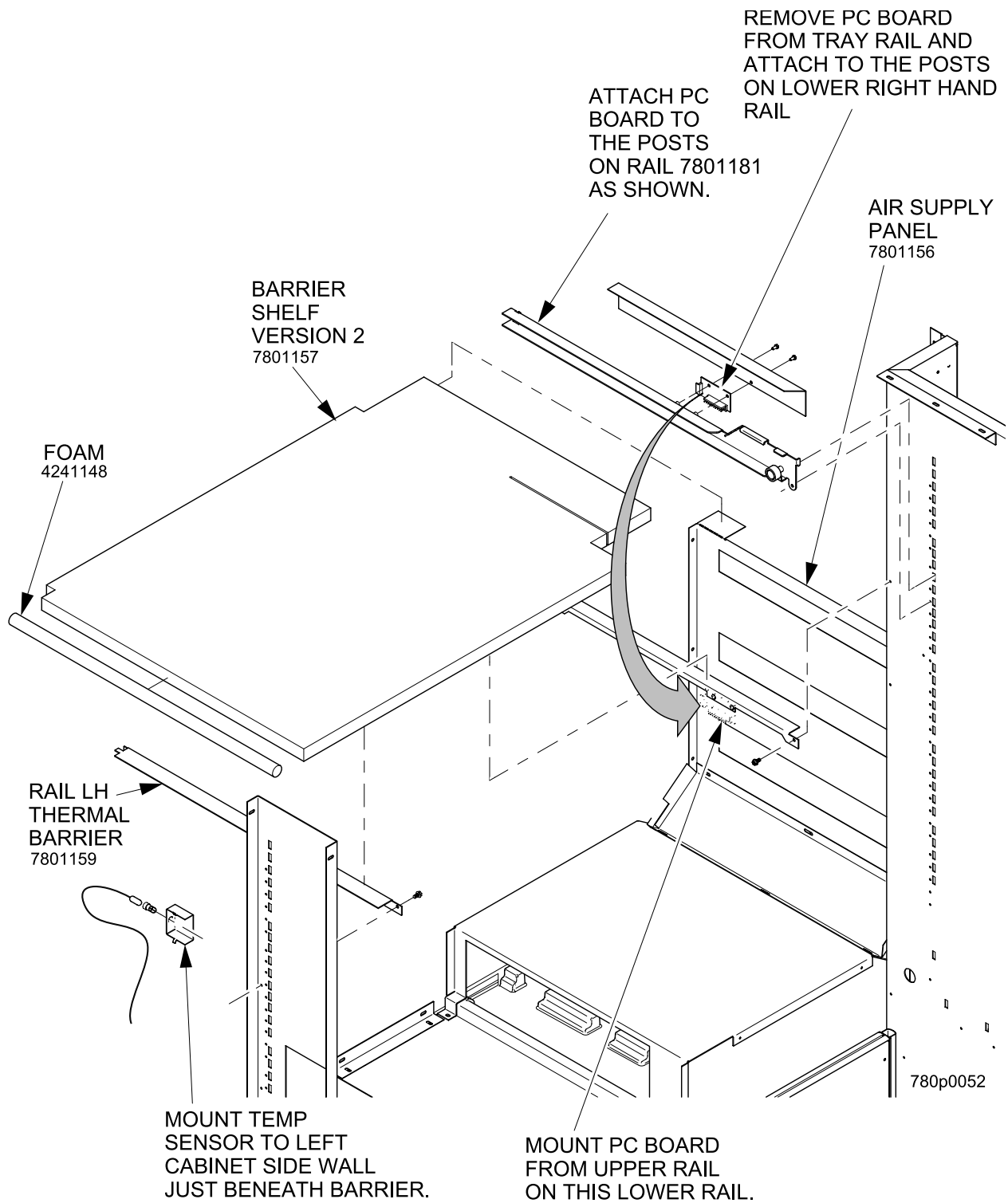

FIGURE 2

**Version 1 Duct system three tray configuration
(See Figure , "Figure 2," on page 13)**

1. You must first remove all trays from your merchandiser.
2. Remove the right two tray rail guides for tray A and B shelf.
3. Remove the tray rail board and the tray shield from the third tray guide rail in the machine.
4. Re-attached the tray shield to the third tray rail.
5. Mount the tray rail board and to the right side of the barriers mounting rail standoffs.
6. Remove the temperature sensor bracket mounted to the left hand side of the cabinet. Do not unplug the sensor, let it hang down the left hand side of the cabinets wall.
7. Position the barrier inside the cabinet just below the third trays rails. Make sure that the fourth tray rail connector plug is left underneath the barrier. You will need to remove the left hand side tray rails underneath the barrier in order to position the barrier.
8. Mount the barriers mounting rails to the sides of the machine using one screw for each rail.
9. Move the barrier to the back right corner of the cabinet leaving a gap on the left hand side of the barrier.
10. Place the 1/2" by 1/2" piece of foam tape on the left side of the cabinet in between the barrier and the cabinet where you have left the gap.
11. Place the large foam board at the upper right side of the air supply panel.
12. Place the small foam board directly underneath the large foam.
13. Bend the flanges on the air supply panel to hold the foam boards in place.
14. Re-mount all tray rails and re-connect all rail connections.
15. Replace all snack and candy trays. You may have to adjust the tray rails underneath the barrier to provide adequate spacing for your trays.
16. Re-mout the temperature probe underneath the barrier in the holes provided on the left inside wall of the cabinet.

Set the machine for a two or three tray configuration version 2:



VERSION 2
FIGURE 3

Version 2 Duct System
(See Figure , "Figure 3," on page 15)

1. You must first remove all trays from your merchandiser.
2. Remove the right tray rail guide for tray A shelf.
3. For steps 4-8 substitute third tray for second tray if configuring machine for three tray configuration.
4. Remove the tray rail board and the tray shield from the second tray guide rail in the machine.
5. Re-attached the tray shield to the second tray rail.
6. Mount the tray rail board to the right side of the barriers mounting rail standoffs.
7. Remove the temperature sensor bracket mounted to the left hand side of the cabinet. Do not unplug the sensor, let it hang down the left hand side of the cabinets wall.
8. Position the barrier inside the cabinet just below the second trays rails. Make sure that the third tray rail connector plug is left underneath the barrier. You will need to remove the left hand side tray rails underneath the barrier in order to position the barrier.
9. Mount the barriers mounting rails to the sides of the machine using one screw for each rail.
10. Move the barrier to the back right corner of the cabinet leaving a gap on the left hand side of the barrier.
11. Place the 1/2" by 1/2" piece of foam rope on the left side of the cabinet in between the barrier and the cabinet where you have left the gap.
12. Re-mount all tray rails and re-connect all rail connections.
13. Replace all snack and candy trays. You may have to adjust the tray rails underneath the barrier to provide adequate spacing for your trays.
14. Re-mout the temperature probe underneath the barrier in the holes provided on the left inside wall of the cabinet.

Section 3: Tray Set-Up

Place a Tray in the Loading Position

1. Place both hands on the tray as shown.
2. Push down on the tray latches with your thumbs.
- 3a. **Bottle Trays:** Pull the tray toward you until the slides are fully extended. The bottle tray can now be loaded--bottle trays do not tilt like snack and candy trays.
- 3b. **Snack and Candy Trays:** Pull the tray toward you until you hear and feel the rear tray rollers drop into a cut-out in the top of the guide rail.

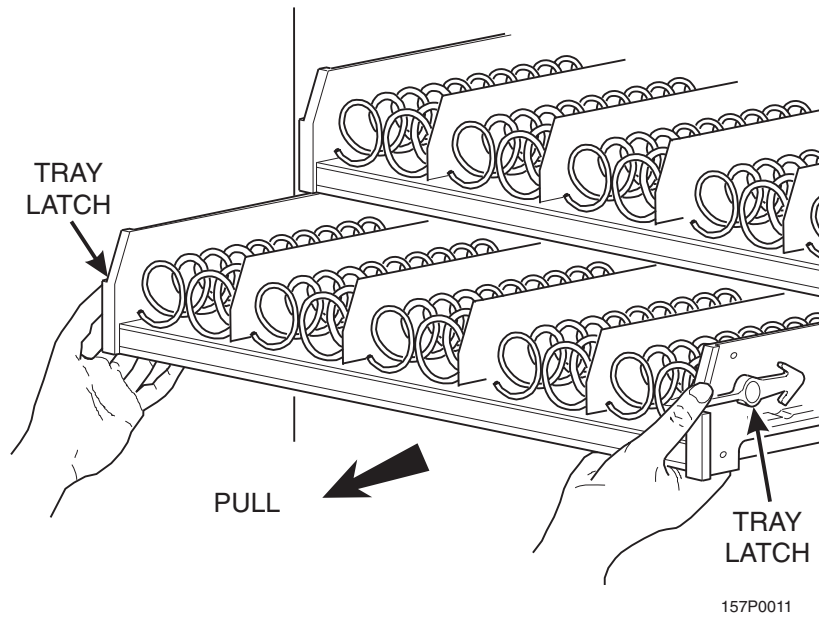

4. Continue pulling the tray forward for another inch. You will then be able to tilt the tray downward into the loading position as shown. The candy or snack tray is now ready for loading.

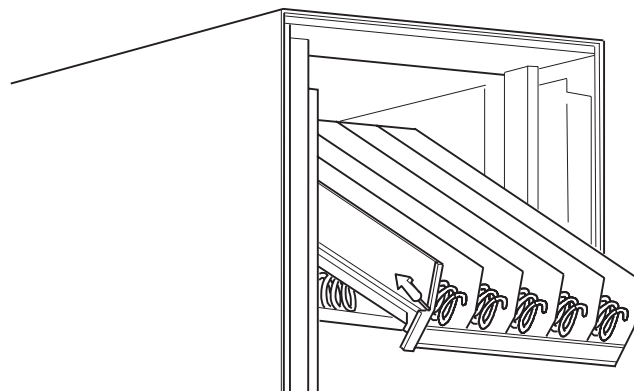

SNACK OR CANDY TRAY IN THE LOADING POSITION

NOTE

When the cabinet door is not fully open, the bottom tray will rest on the delivery pan assembly. Handle the tray with care to avoid scratching the delivery pan assembly.

Set up Trays to Vend Products

These instructions will guide you through setting up your trays for vending. You will be asked to determine if your tray can physically hold the products you intend to vend. If not, you will be directed to other procedures which will help you get them set up. Follow these nine steps for each tray in your machine:

1. Make sure the tray is in the loading position.
2. Is the column wide enough for the intended product? If so, proceed to the next step. Otherwise, set up your tray to vend wider products (see below, this page). When you're done, return to step 3 in this procedure.
3. Will the products fit between the spiral turns? If so, proceed to the next step. Otherwise, change the spiral.
4. Will the product pass under the tray immediately above? If so, proceed to the next step. Otherwise, reposition the tray and guides.
5. Will the product touch products on either side? If not, proceed to the next step. Otherwise, install a product spacer.
6. Load products in the tray.
7. Return the tray to the vending position.
8. Install the price rolls.
9. Install the selection ID numbers.

Set Up A Tray To Vend Wide Products

The following steps will help you configure your tray to vend wide products. When you are done with the entire wide product steps, return to the set-up procedures above.

NOTE:

Does not apply to bottle trays - they cannot be reconfigure.

1. Remove the tray from the merchandiser and place it on a flat surface.
2. Based on the size of the product you want to vend, decide how many spiral positions it will occupy. Please remember that the left most spiral in the group **must** have an even ID number (0, 2, 4, etc.) For example, if a product is three spirals wide, the left spiral will be ID number 0, and the right spiral will be ID number 2. Be careful how wide you set up for, because some wide products could get hung up in the delivery door.
3. Remove the column dividers inside the group. In the example of three spiral positions, you would be removing the dividers between spiral ID numbers 0 and 1, and 1 and 2.
4. If your group only consists of 2 spirals, replace the right most motor with a spiral bearing and gear, and install a gear on the left most motor. Skip to step 8.
5. Remove all spirals in the group except the left most spiral.

6. Do one of the following:
 - a. If your group has an **ODD** number of spirals (3, 5, etc.) remove the harnesses from all motors in the group except the left most one. To the right most motor, connect the harness from the motor immediately to its left.
 - b. If your group has an **EVEN** number of spirals (4, 6, etc.) remove the harnesses from all motors **inside** the group (leave the harnesses connected to the left most and right most motors).
7. Install a spiral at the right most position in your group. Make sure it has the same product capacity and is opposite to the one in the left most position.
8. Return the tray to the merchandiser.
9. Electronically couple the motors as needed (see "**Couple/Uncouple Tray Motors**" on page 67).
10. Return to step 3 in the "**Set up Trays to Vend Products**" on page 18.

Study this procedure **before** you install a tray for the first time; while you are holding the tray you will not be able to see this area.

Remove a Snack or Candy Tray

1. Remove all product from the tray.
2. Push down on the tray latches with your thumbs.
3. Pull the tray toward you until you hear and feel the rear tray rollers drop into a cut-out in the top of the guide rail.

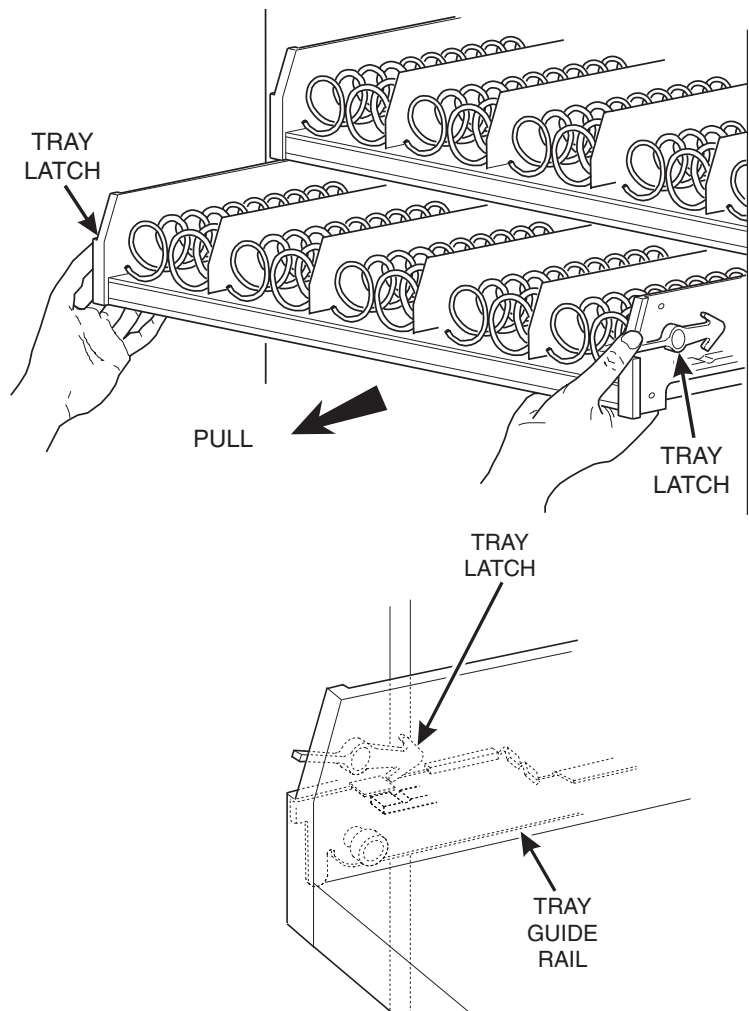

- Unplug the tray wiring harness from the PC board mounted on the tray guide rail IMMEDIATELY ABOVE the tray you are removing.

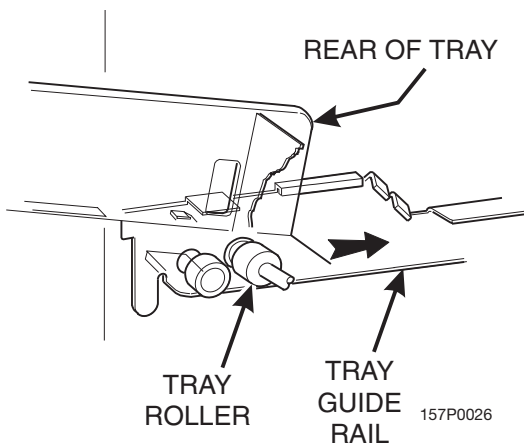
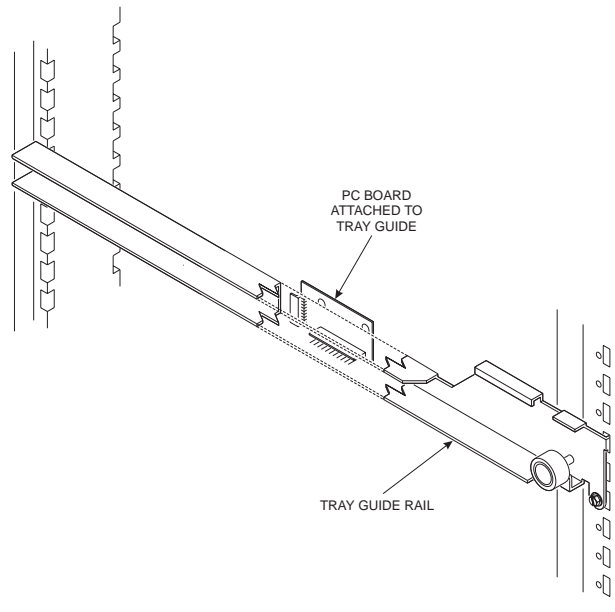

- Lift up on the tray and slide it toward the back. No more than an inch should be needed.
- The tab near the back of the tray should align with the cut-out in the top of the guide rail as shown.

- Lift the tray clear of the guide rail and out of the merchandiser.

CAUTION

When the cabinet door is not fully open, use extra care in removing the bottom tray. Failure to do so may result in damage to the tray or to the delivery pan assembly.

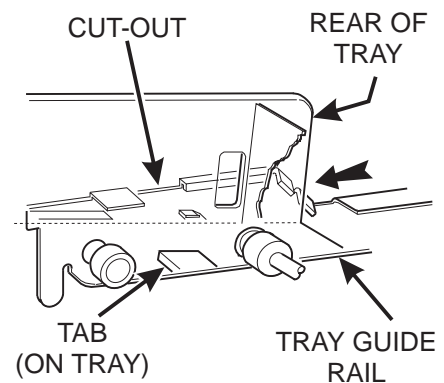

Remove a Bottle Tray

1. Remove all product from the tray.
2. Push down on the tray latches with your thumbs and slide out the tray as far as it will go.
3. Unplug the tray wiring harness from the PC board mounted on the tray guide rail IMMEDIATELY ABOVE the tray you are removing.
4. Locate a small lever on each side of the tray, where it attaches to the slide. The left lever will be up, the right will be down. Press down on the left lever and up on the right lever.

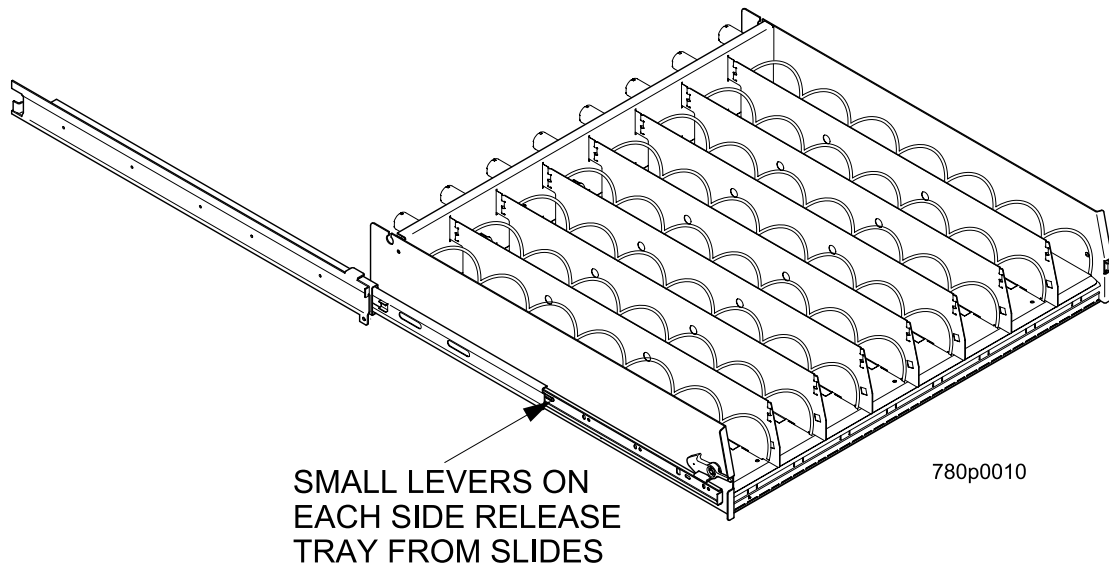

5. Pull the tray towards you, off of the slides.
6. Replace the tray by performing the above steps in reverse order.

NOTE:

It is much easier to replace a bottle tray if you have assistance lining up the tray rails and slides.

Remove and Install Column Dividers

Note: Not applicable to bottle trays.

1. Push the column divider toward the back of the tray - ①.
2. Lift the column divider clear of the tray - ②.
3. Install the column divider in the reverse order of removal.

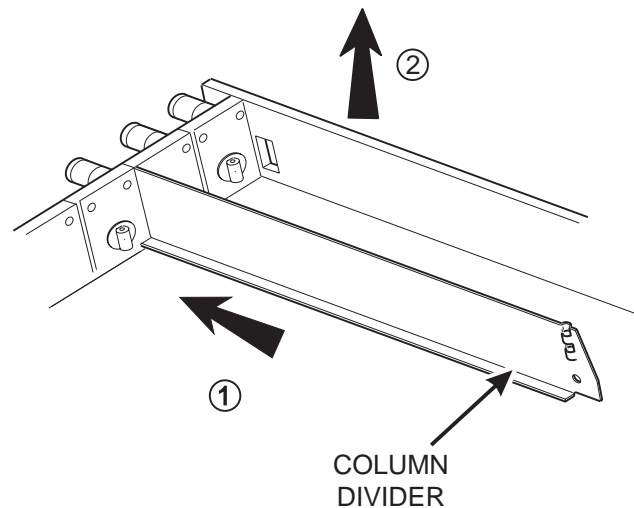

Operate a Tray Outside of the Machine

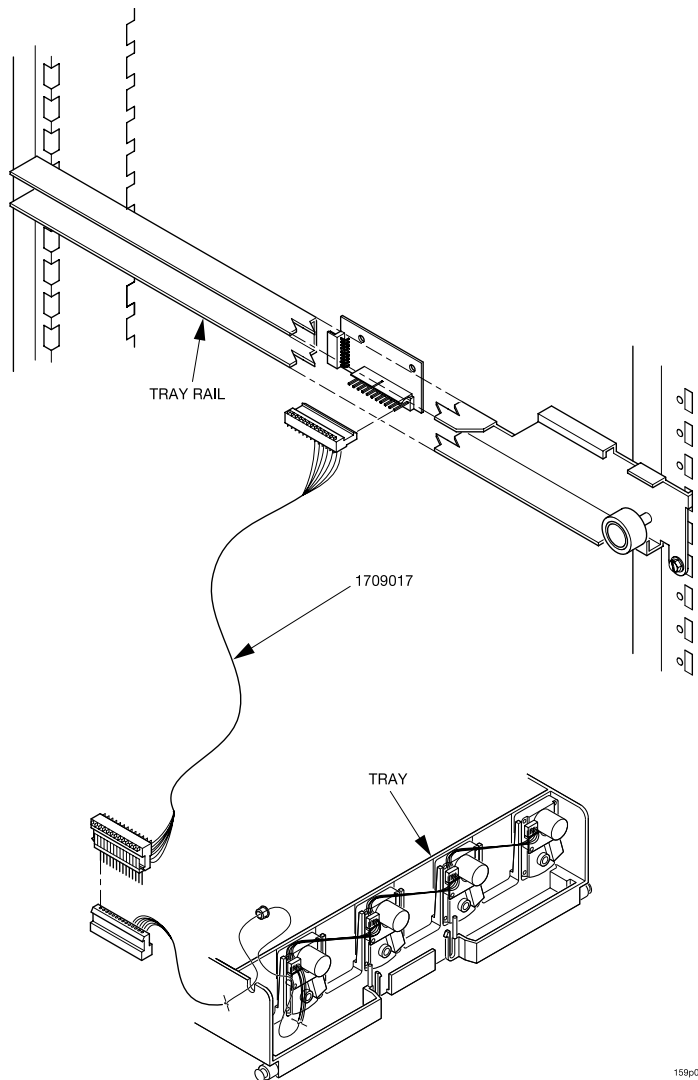

Use tray harness extension (P/N 1709018) available from your National Vendors Parts department (1-800-621-7278). The extension will enable you to remove the tray from the machine and still operate the motors and spirals. Connect it as shown below:

Replace a Motor with a Spiral Bearing

Remove A Motor:

1. Disconnect the harness from the motor.
(See "**Connect and Disconnect a Motor Harness**" on page 24).
2. Remove the spiral. (See "**Remove and Install Spirals**" on page 25).
3. Remove the spiral coupler. (See "**Remove a Spiral Coupler**" on page 26).
4. Remove the motor. (See "**Remove and Install a Spiral Motor**" on page 27).
5. Install A Spiral Bearing:
 - a. Put the gear into position in this set-up as shown.

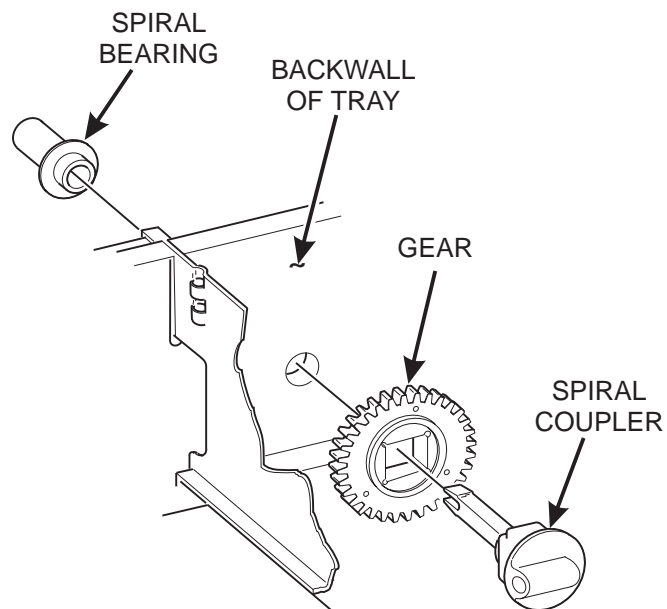

- b. Install the spiral coupler. (See "**Install a Gear**" on page 28).

Connect and Disconnect a Motor Harness

CAUTION

To avoid breaking the motor circuit board, hold the header on the circuit board whenever connecting or disconnecting a motor harness.

Disconnect a Motor Harness:

1. Pull the harness connector away from the circuit board as shown.
2. Tuck the unused part of the harness out of the way in the trough at the back of the tray.

Connect a Motor Harness:

1. Locate the harness connector for the appropriate tray position.
2. Push the harness connector over the header pins on the motor circuit board as shown.

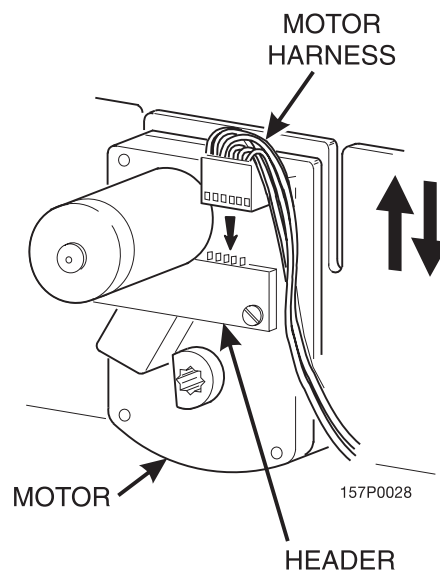

Remove and Install Spirals

- All spirals are the same diameter
- There are two kinds of spirals

Counter Clockwise (left-hand)

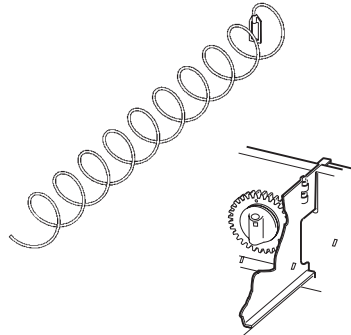

Clockwise (right-hand)

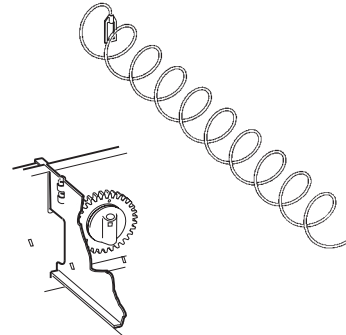

SNACK AND CANDY TRAY SPIRAL OPTIONS

		COUNTER CLOCKWISE (LEFT HAND)		CLOCKWISE (RIGHT HAND)		
SPIRAL COUNT	RETAINER COLOR	ASSEMBLY	SPIRAL	ASSEMBLY	SPIRAL	RETAINER
6	PURPLE	1477103	1477102	1477105	1477104	1477107
8	BLACK	1677247	1677190	1677248	1677189	1477073
9	GRAY	1477152	1477153	1477149	1477150	1477155
11	BLUE	1477023	1477024	1477026	1477027	1457061
13	YELLOW	1477029	1477030	1477032	1477033	1457062
15	RED	1477035	1477036	1477038	1477039	1457063
17	BROWN	1477101	1477100	1477099	1477098	1477106
20	WHITE	1477041	1477042	1477044	1477045	1457064
25	GREEN	1477047	1477048	1477050	1477051	1457065
30	BLACK	1477053	1477054	1477056	1477057	1477073
38	ORANGE	1477059	1477060	1477062	1477063	1467137

NOTE

Bottle trays use a 3.25" diameter spiral.

BOTTLE TRAY SPIRAL OPTION				
SPIRAL COUNT	RETAINER COLOR	ASSEMBLY	SPIRAL	RETAINER
6	DARK GREEN	7807011	7807003	4407822
7	RED	7807015	7807016	1457063

To Remove a Spiral:

1. Pull forward on the retaining clip and remove the end of the spiral from the spiral coupler as shown.
2. Remove the spiral from the tray.

To Install a Spiral:

1. Pull the bottom of the retaining clip toward the front of the spiral.
2. Lower the spiral into the tray column and insert the end of the spiral into the spiral coupler as shown.
3. Release the retaining clip.

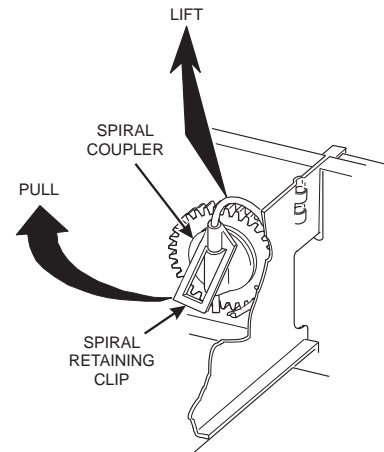

Choose a Clockwise or Counterclockwise Spiral

1. The type of spiral used is determined by the column position it will occupy in the tray.
2. Refer to the figure below to find the correct spiral type.

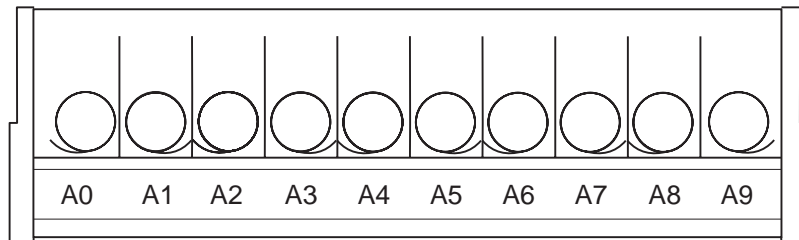

Note: Bottle spirals are all clockwise.

Remove a Spiral Coupler

1. Pinch together the prongs on the end of the spiral coupler as shown.
2. Pull the coupler forward (in the direction of the arrow as shown)

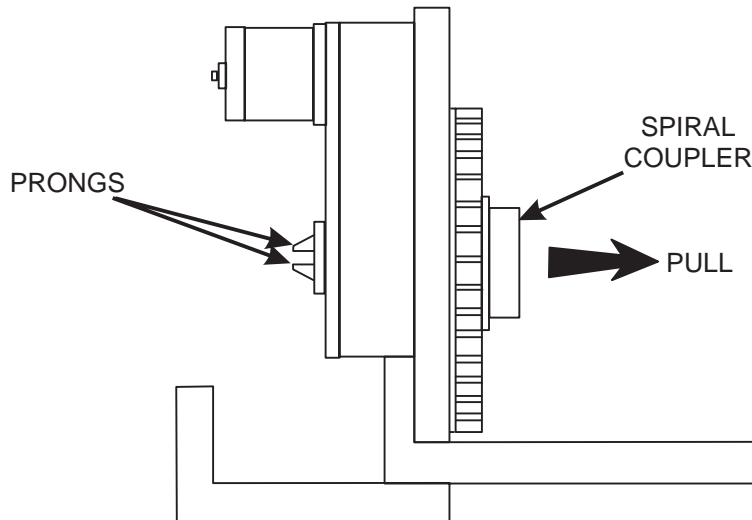

Remove and Install a Spiral Motor

Remove a Spiral Motor:

NOTE

Some steps may already be completed

1. Remove the tray. (See "**Remove a Snack or Candy Tray**" on page 19).
2. Disconnect the motor harness. (See "**Connect and Disconnect a Motor Harness**" on page 24).
3. Remove the spiral. (See "**Remove and Install Spirals**" on page 25).
4. Remove the spiral coupler. (See "**Remove a Spiral Coupler**" on page 26).
5. Lift the motor clear of the tray.
6. Return the tray to the merchandiser. (See "**Install a Tray in the Merchandiser**" on page 31).

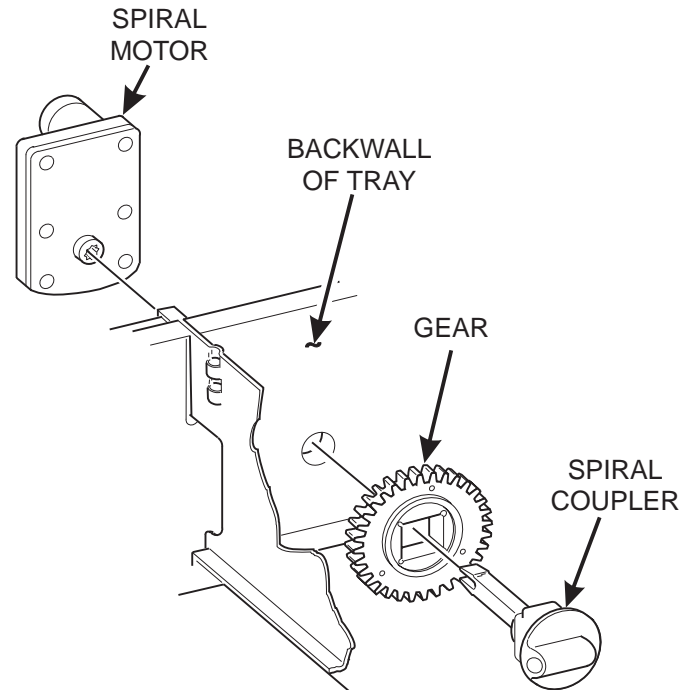

Install a Spiral Motor:

1. Remove the tray. (See "**Remove a Snack or Candy Tray**" on page 19).
2. Place the motor in the correct position at the rear of the tray as shown.
3. Place a gear in position if required by this set-up.
4. Install a spiral coupler in the proper orientation. (See "**Install a Gear**" on page 28).
5. Connect the motor harness. (See "**Connect and Disconnect a Motor Harness**" on page 24).

Install a Gear

Use a Gear when:

- Gears are used to mechanically couple the spirals together.
- This happens whenever you have two spirals and only one motor for vending a selection.

Position the Gear

- Place the gear in between the back of the tray and the spiral coupler.
- There are two possible orientations for the gear:

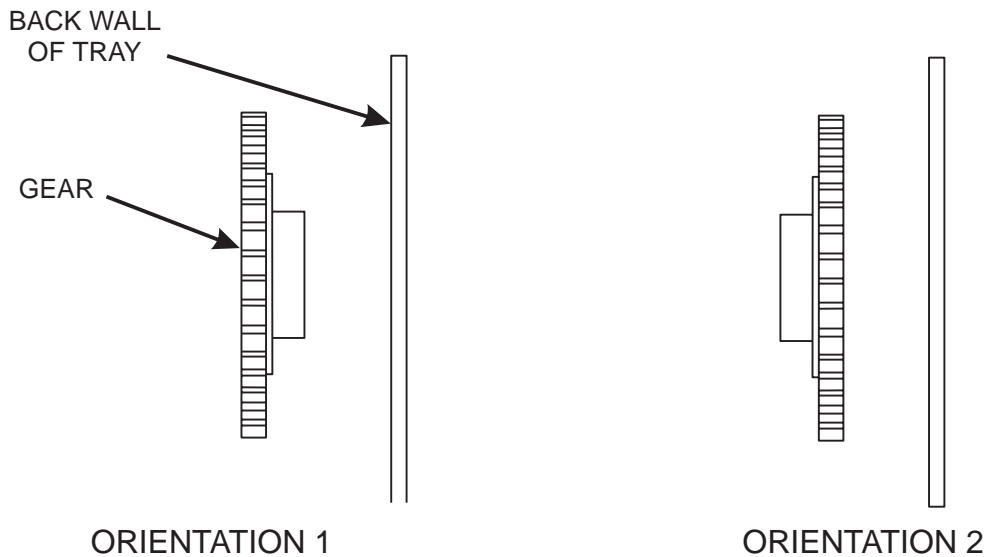

- There are two rules to follow when orienting gears:

RULE 1 The gears for selections next to each other cannot use the same orientation.

RULE 2 All gears for a single selection must use the same orientation.

Install a Spiral Coupler

1. Place the gear in position if one is required for this set-up.

When Used with a Motor:

2. Hold the motor in place and push the spiral coupler through the motor gear box until it clicks into position. Be sure the spiral couplers are oriented as shown below.

NOTE

The motor output shaft opening contains eight facets to allow the spiral coupler to be installed in any one of eight positions.

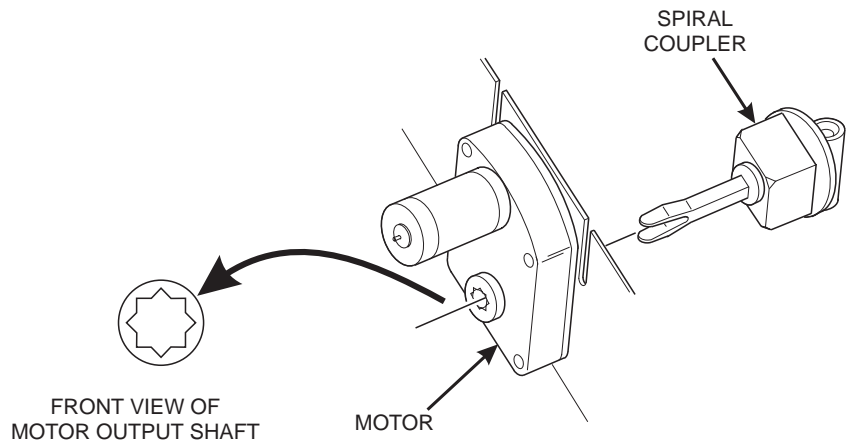

Spiral Coupler Orientation

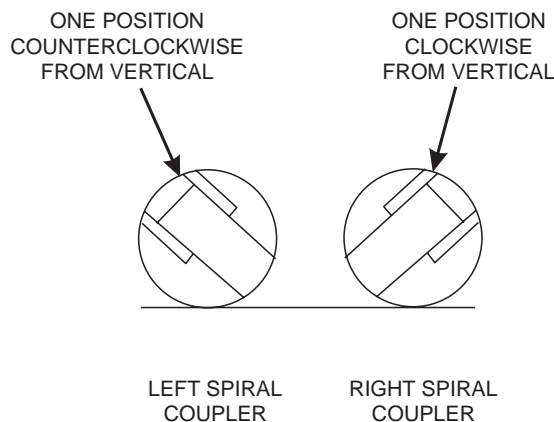

AS VIEWED FROM FRONT OF TRAY

When Used with a Coupler Bearing:

3. Hold the coupler bearing in place and push the spiral coupler through the bearing until the coupler clicks into position. Be sure the coupler is in the proper orientation as shown.

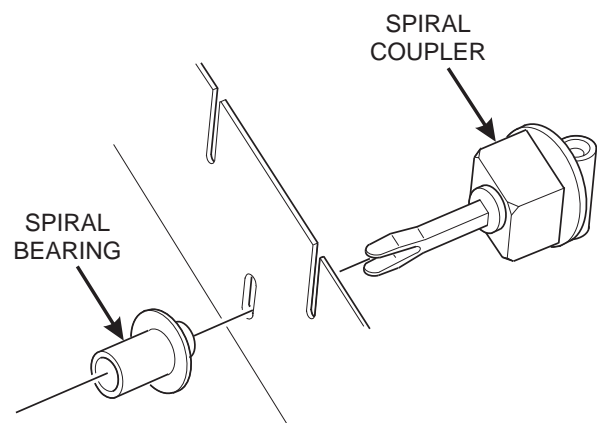

Move a Tray Up or Down

This merchandiser can be adjusted to vend taller products. Follow the guidelines below:

- Keep in mind that when you increase the product height available to a tray by lowering it, you will be decreasing the product height available to the tray below.
- If a tray is in the lowest position, the tray below it should not be in the highest position.
- If a tray is in the highest position, the tray above should not be in the lowest position.
- You may need to experiment with various tray positions to get the best results for your products.

CAUTION

The trays in should not be positioned over an open air discharge vent.

NOTE

Tray movement is limited because the tray harness will limit the amount of travel available to the tray guide rails.

Proceed as follows:

1. Remove the tray from the merchandiser. (See "**Remove a Snack or Candy Tray**" on page 19).
2. Remove the screw that secures the right tray guide rail to the front guide mounting channel as shown.
3. Tap up on the guide rail and unseat the guide rail tabs from the channel slots.
4. Pull the guide rail away from the front and rear guide mounting channels.
5. Move the guide rail to the desired position.
6. Insert the guide rail tabs into the mounting channel slots as shown.
7. Tap down on the guide rail to seat the tabs in the channel slots.
8. Replace the screw that secures the guide rail to the front guide mounting channel.
9. Repeat steps 2 through 8 for the left guide rail.
10. Return the tray to the merchandiser. (See "**Install a Tray in the Merchandiser**" on page 31).
11. Load products into the trays, and perform test vends. Make sure the trays don't interfere with the products you are vending, and that all products vend properly.

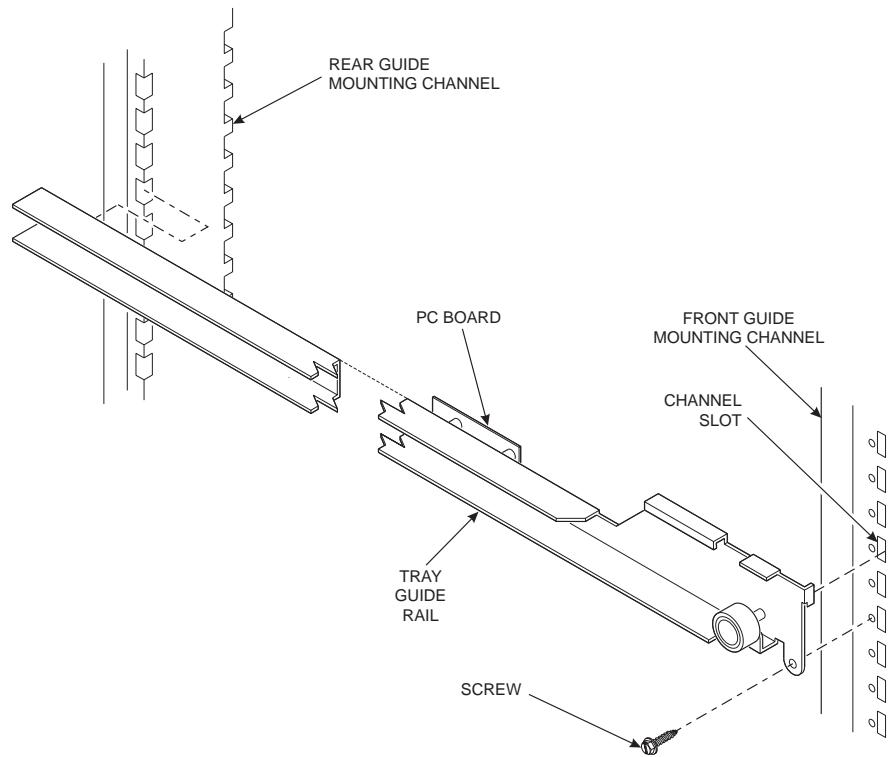

Install a Tray in the Merchandiser

- Study this procedure before you install a tray for the first time; while you are holding the tray you will not be able to see this area. Proceed as follows:
1. Insert the tray so that the tray rollers pass over the tray guide rollers.
 5. Hold the tray up while pushing it toward the rear. Stop when the tab on the tray aligns with the opening in the tray guide.

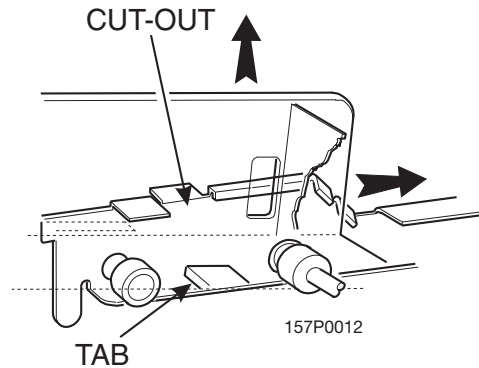
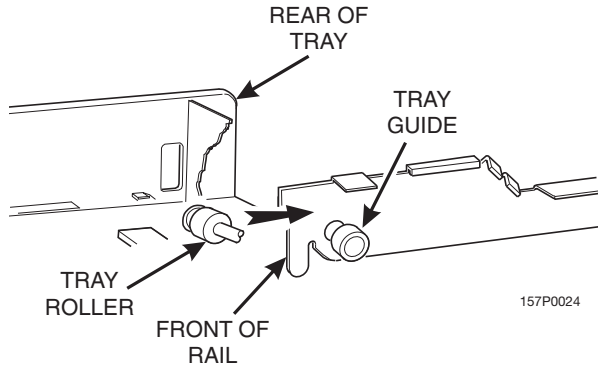

2. Bring the tray roller to rest on the tray guide.
6. Lower the tray until it rests on the tray guide roller. Push the tray in all the way.
7. The tray latch will fall into the locking position.

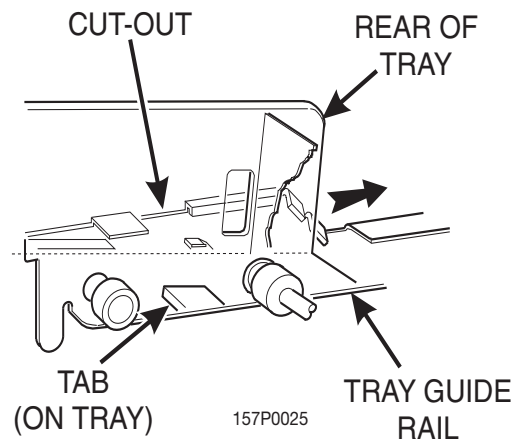
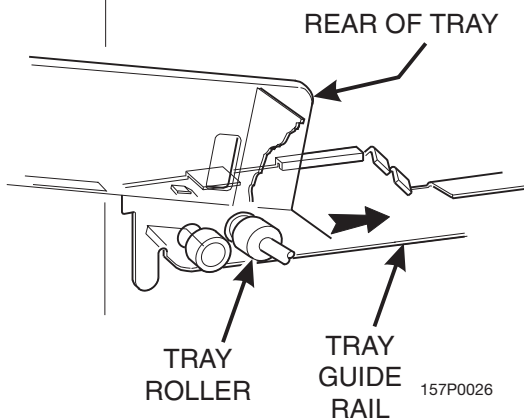

3. Tilt the tray upward.
4. Connect the tray wiring harness to the PC board mounted to the guide rail JUST ABOVE the tray you are installing.

NOTE:
Does not apply to bottle trays.

Install and Remove a Product Spacer

Install a Product Spacer

The product spacer will keep a tall, narrow product upright.

Shown at right are spacers and column dividers on both deep and shallow trays. Insert the product spacer onto the column divider as shown.

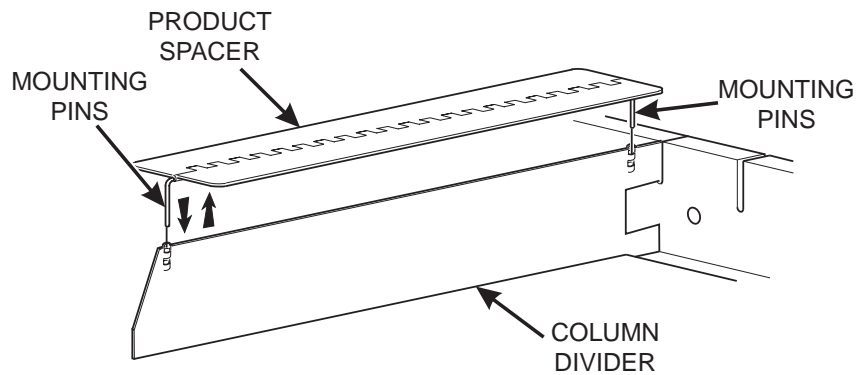

Adjust a Product Spacer

With product loaded in the tray, rotate the product spacer up or down to keep the product upright as shown.

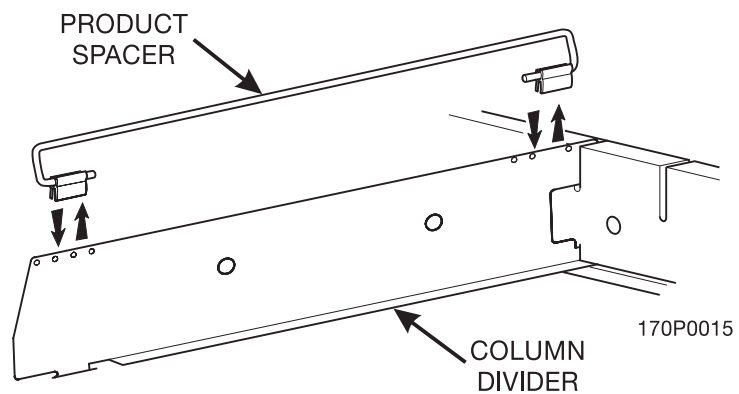

Remove a Product Spacer

Pull the product spacer mounting pins from the column divider.

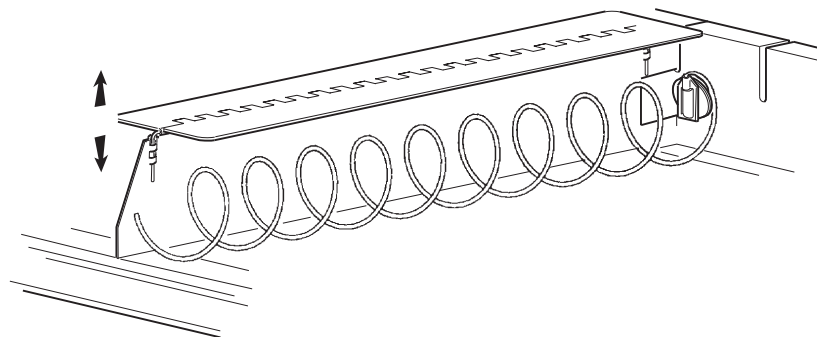

Section 4: Load the Merchandiser

The color of the spiral coupler (the little plastic tab attached to the rear of the spiral) will tell you how many products will fit in the spiral. (See table below).

NOTE

Another way to determine spiral capacity is to count the spaces in the spiral!

SPIRAL CAPACITY COLOR CODES

SPIRAL CAPACITY	SPIRAL COUPLER COLOR	SPIRAL CAPACITY	SPIRAL COUPLER COLOR
6	Purple	17	Brown
8	Black	20	White
9	Gray	25	Green
11	Blue	30	Black
13	Yellow	38	Orange
15	Red		

General Tray Loading:

- See "**Product Pusher Usage**" on page 35 for spirals with capacity of 11, 13, or 15.
- See "**Spiral Wall Retainer Usage**" on page 34 for spirals with capacity of 20, 25, 30, or 38.
- Begin loading products at the front of the tray and work toward the back. Position the product so the package rests on the tray. **DO NOT** force a product into a spiral.
- If the fit is too tight or too loose, change the spiral size.
(See "**Remove and Install Spirals**" on page 25).
- Be sure there are no empty positions between products in each spiral.

Special Considerations:

Bagged Products Position package upright, then push the tops slightly toward the rear of the tray. Also, (see "**Product Pusher Usage**" on page 35).

Thin Packages Position the package upright.
Also, (see "**Spiral Wall Retainer Usage**" on page 34).

KitKat The two right-most columns of the candy tray are designed to accept the KitKat candy bar.

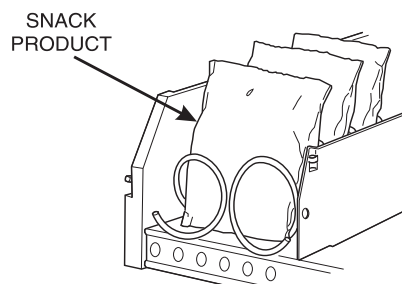

**CORRECT LOADING
OF SNACKS**

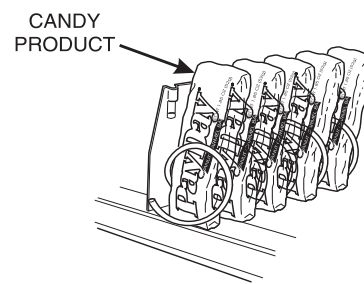

**CORRECT LOADING
OF CANDY** 157P0035

Spiral Wall Retainer Usage

A spiral wall retainer serves to compress the spiral and make it act like a spring to more forcefully eject a product. Do some test vends and use a spiral wall retainer when a product does not readily leave the spiral.

- Use a spiral wall retainer in the following cases:
 - The spiral has a capacity of 20, 25, 30, or 38.
 - The product is thin.
 - The product is on a candy tray.
- The spiral wall retainer can also be used with other spirals and types of products.
- The spiral wall retainer is installed near the front of the column divider.
- There are two ways to install the spiral wall retainer.

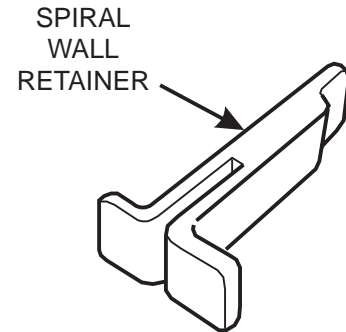

	RETAINER ORIENTATION	
	A	B
COLUMN DIVIDER BETWEEN THESE POSITIONS	0 and 1	1 and 2
	2 and 3	3 and 4
	4 and 5	5 and 6
	6 and 7	7 and 8
	8 and 9	

- To install a spiral wall retainer, insert the retainer in the square slot near the front of the column divider.
- The spiral wall retainer must be removed in two cases:
 - A KitKat bar loaded into either of the two right hand positions of a tray will not clear the retainer on the column divider between the two positions.
 - A product pusher will catch on a retainer in *ORIENTATION A*.

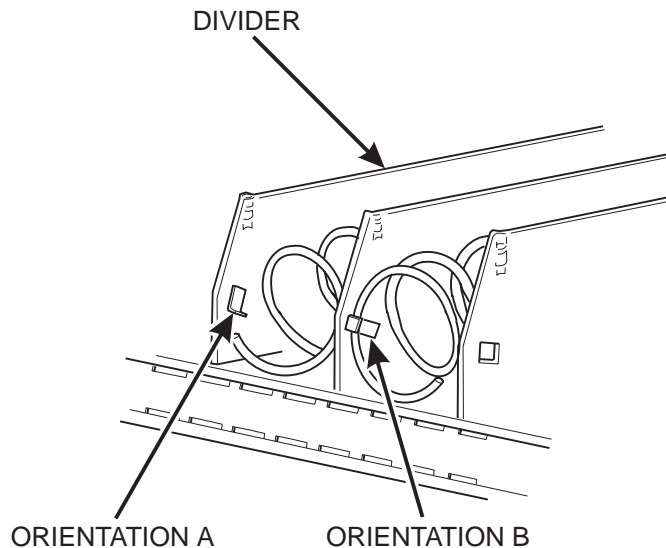

Product Pusher Usage

The product pusher will give the top of a product an extra tilt to help it fall into the delivery pan.

Use a product pusher in the following cases:

- The spiral has a capacity of 15, 13, or 11.
- The package is non-rigid like bagged peanuts

The product pusher can also be used with other spiral and types of products.

A bag of product pushers has been shipped with the merchandiser. Additional product pushers are available from the National Vendors' parts department (800-621-7278). To use a product pusher, snap it on the spiral as shown. You can adjust the product pusher by moving it around on the spiral to achieve the best vending results.

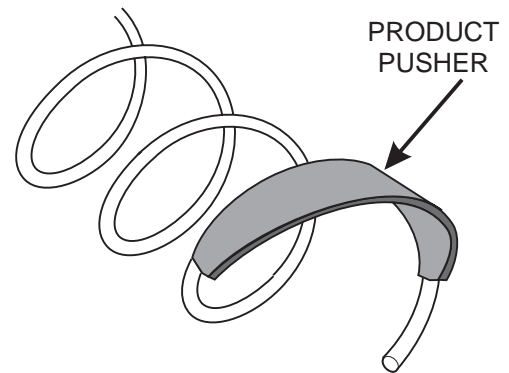

Configure the Merchandiser to vend "Lunch Buckets"

Because of the weight and shape of the package, National Vendors recommends that this product be vended only from the bottom tray.

To vend this product, two adjacent positions must be coupled together.

The left spiral coupler should be installed one position counterclockwise from the vertical position.

ONE POSITION
COUNTERCLOCKWISE
FROM VERTICAL

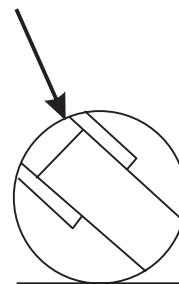

LEFT SPIRAL
COUPLER

ONE POSITION
CLOCKWISE
FROM VERTICAL

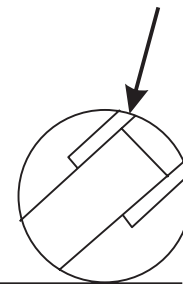

RIGHT SPIRAL
COUPLER

AS VIEWED FROM FRONT OF TRAY

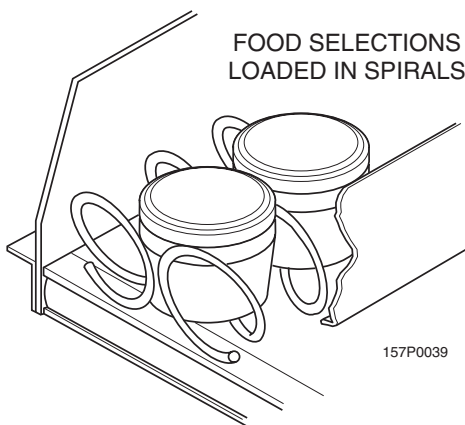

The right spiral coupler should be installed one position clockwise from the vertical position.

Replace the current spirals with six-count spirals. These are available from the National Vendors parts department. (See "**Remove and Install Spirals**" on page 25). A pad can be installed in the bottom of the delivery pan to quiet and cushion product delivery. This part is available from the National Vendors parts department. Load "Lunch Bucket" products as shown at left.

Configure the Merchandiser for Vending "Top Shelf"

National Vendors recommends that this product be vended from a candy tray.

1. Move the tray so the package can be loaded standing on its left or right edge.
(See "Move a Tray Up or Down" on page 30).
2. The following steps must be completed for three adjacent positions on the tray:

NOTE

The left-most position in the group of three must be an even numbered position.

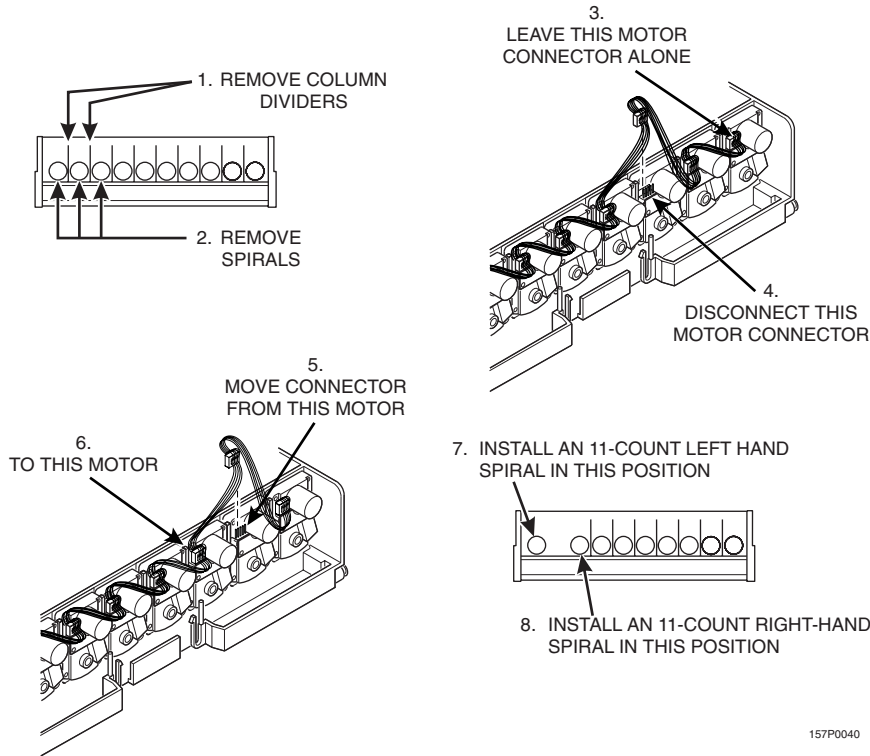

NOTE

If the motor harness disconnected in step 5 does not reach, use the motor skip harness, (P/ N 1599024), available from the National Vendors Parts Department (800-621-7278).

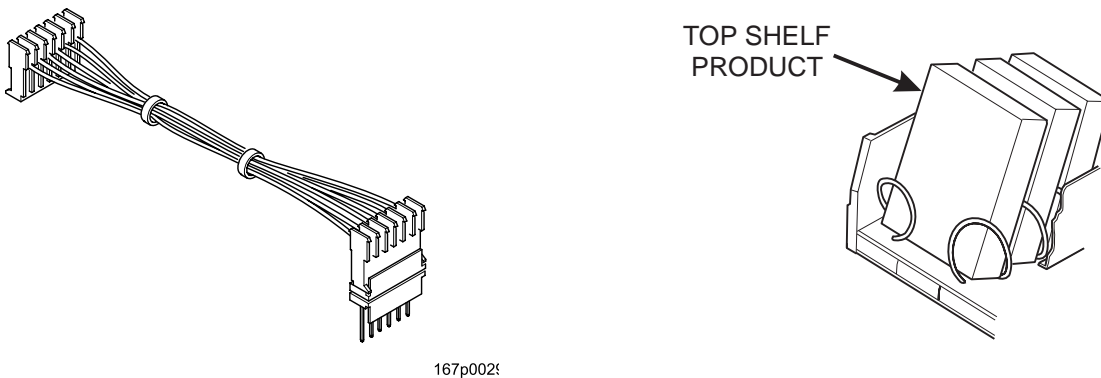

3. Couple the left motor to the right motor. (See "Couple/Uncouple Tray Motors" on page 67).
4. Load the "Top Shelf" products as shown.

Return the Trays to the Vending Position

1. Lift the tray until it is parallel to the floor as shown.

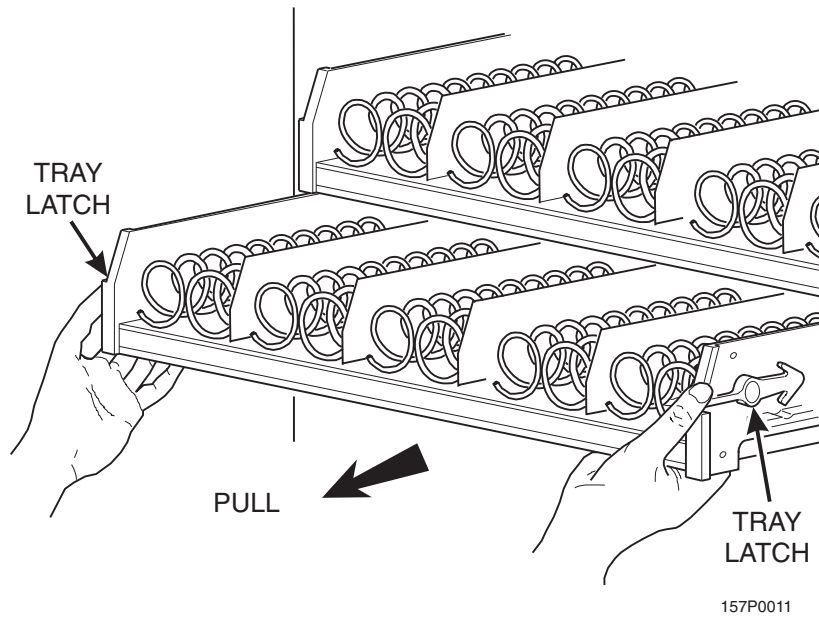

2. Push the tray toward the back of the cabinet. The tray latches on the sides of the tray will lock into position.

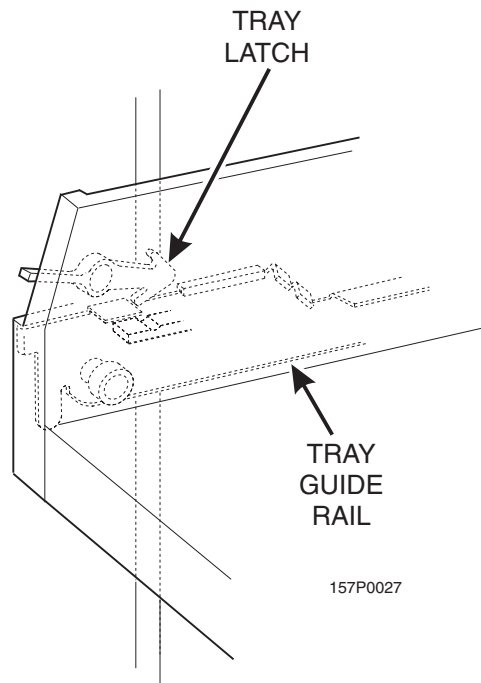

Install and Set Price Labels

- Price rolls are printed on coiled strips as shown in the illustration below. (The dollar and cents rolls are factory installed.) If you use another type of currency, you will find the appropriate price rolls in the plastic bag that contained this manual.
- There are two types of price rolls:
 - Dollar roll 1 to 12, increments of 1
 - Cents roll 00 to 95, increments of 05
- Remove the price rolls as required, and install the appropriate ones for your currency.

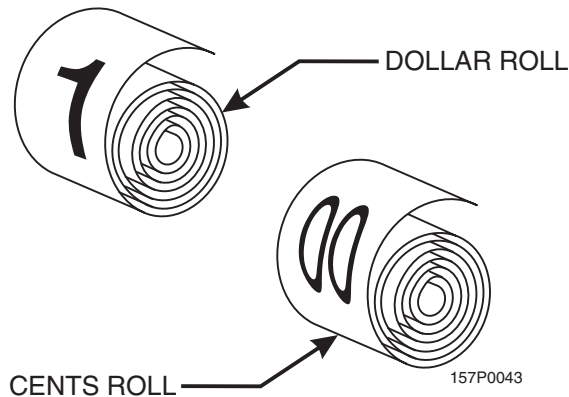

Install Price Labels:

There are three pairs of slots in the front of the can unit for each position. Install per this example:

1. Insert the dollar roll in the left-most pair of slots as shown if the price is \$1.00 or more.
2. Insert the cents roll in the center pair of slots as shown.
3. The low-number end of the roll goes in the top slot and the high-number end of the roll goes in the bottom slot.

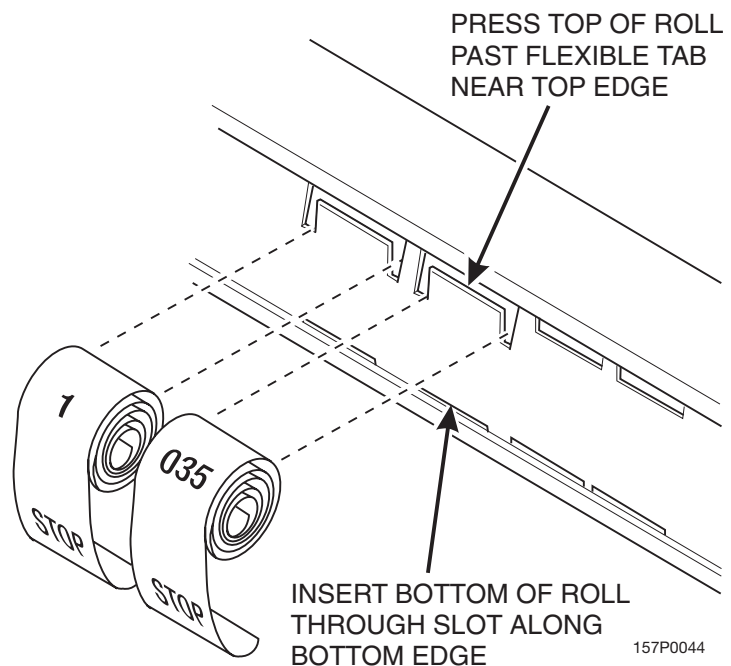

Adjust the Price Roll:

You can set selection prices within the following range:

Minimum price	\$.00
Maximum price	\$99.99
Increment	\$.05

1. Use your thumb as shown to move each price roll up or down as needed to set the desired price.

NOTE

You will see the word **STOP** near either end of the roll.

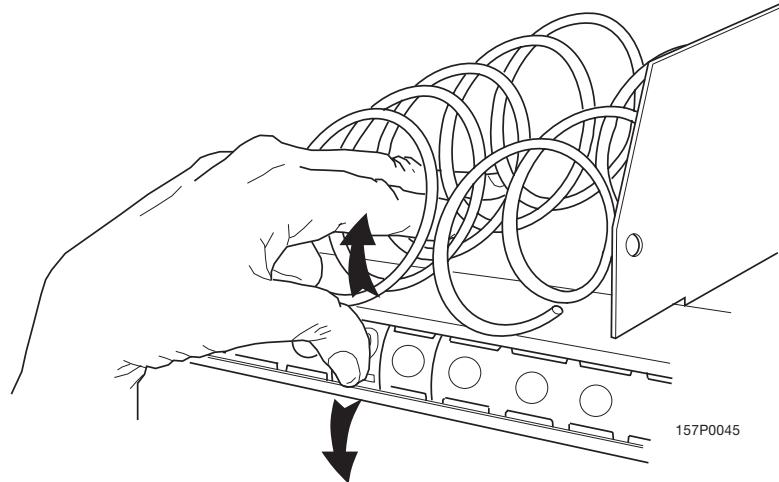

Selection ID numbers are printed on clear plastic sheets. You will find these in the plastic bag that contained this manual. You will need to separate them along the scored lines between the selections. **BE CAREFUL** when doing this, as it is easy to split the labels.

Install the Selection ID Numbers:

1. Press together the two long edges of the selection ID label.
2. Snap the selection ID label into position on the front of the tray as shown.

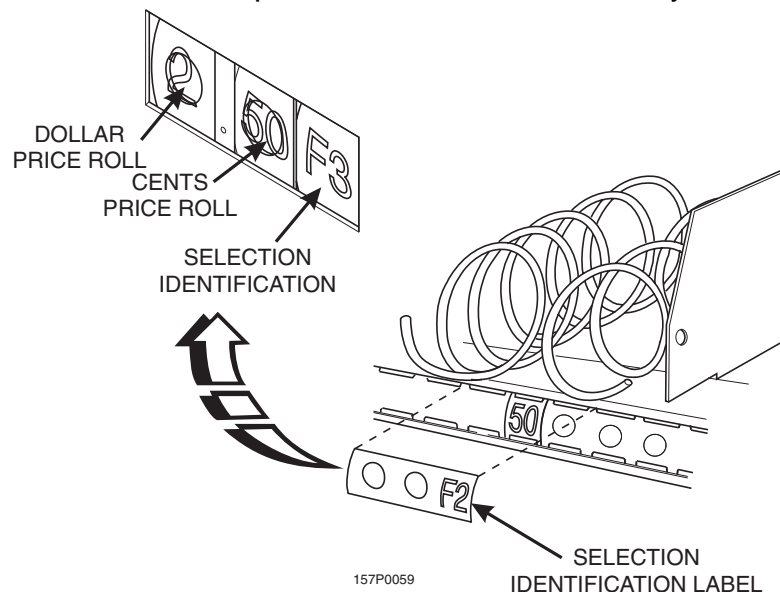

See the figures below for snack and candy tray positions.

MOTOR POSITION

TOP TRAY

TRAY A	A0	A1	A2	A3	A4	A5	A6	A7	A8	A9
TRAY B	B0	B1	B2	B3	B4	B5	B6	B7	B8	B9
TRAY C	C0	C1	C2	C3	C4	C5	C6	C7	C8	C9

BOTTOM TRAY

NOTE

This example shows a 3-tray merchandiser.
Some merchandisers can have up to 6 trays.

Example of a Basic
Snack Tray ID Label to Use

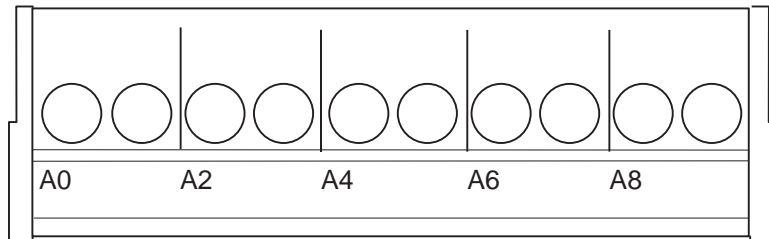

Example of a Basic
Candy Tray ID Label to Use

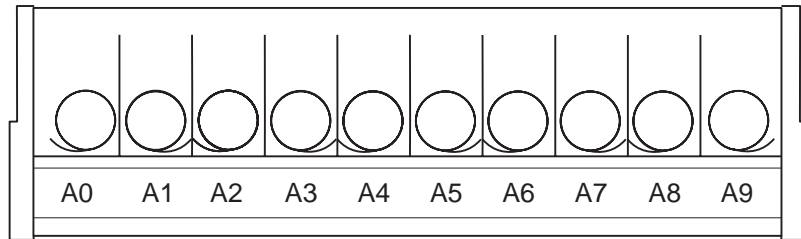

Section 5: SureVend™

The SureVend™ product detection system consists of several infrared light emitters and infrared light detectors that scan the product delivery area with a pattern of crisscrossed light beams. While the machine is idle, the SureVend™ system is constantly calibrating itself for optimum performance in all temperature, humidity, dust, and alignment conditions. The SureVend™ detection system is used by the controller to assure that the selected product is delivered.

- When a customer makes a selection, the controller checks that the SureVend™ detection system is ready and tells it to begin scanning for the product. Different scanning patterns are used depending upon the size and shape of the product.
- The vending machine controller then starts the delivery motor and constantly checks the SureVend™ system for detection of the delivered product.
- If no product delivery is detected, the controller continues to run the delivery motor for up to three revolutions, pausing momentarily at the home position of each revolution of the motor.
- If no product is detected after the third revolution, the selection is marked as empty and the customer's credit is optionally restored to make another selection or is automatically returned.
- If product delivery is detected before the delivery motor has come to the home position for the first time, the delivery motor continues running to its home position.
- If the delivery motor has already passed the first home position, the motor will stop immediately upon product detection to avoid the possibility of vending a second product.

NOTE:

A fatal malfunction in the SureVend™ detection system during the vend is treated the same as a product delivery. It is assumed that the malfunction is due to tampering or vandalism.

Anti-Jackpot provides protection against unforeseeable cheating of the SureVend™ system. If a certain number of SureVend™ empty conditions occur, SureVend™ will disable itself for a few minutes. A SureVend™ empty condition occurs when product delivery is not detected and the customer's money is restored or returned. Both the number of SureVend™ empty conditions required to disable SureVend™, and the number of minutes it remains disabled, are both configurable by the operator (see "**Set SureVend Up the SureVend Anti-Jackpot Feature**" on page 66).

Once Anti-Jackpot is triggered, the SureVend™ system will be turned off for a certain number of minutes so that money can no longer be refunded because of vend failure and thus discourage a thief from remaining. While SureVend™ is disabled, machine will either revert to home switch operation or go out of service, depending on other selected options (see "**Set Up Basic SureVend™ Options**" on page 66).

Once the Anti-jackpot time has elapsed, SureVend™ is re-enabled. The total number of SureVend™ empty selections, the number of anti-jackpot occurrences, and the date and time of the most recent occurrence are recorded.

Section 6: Health Control

NOTE:

The following section applies only to the 780 Refreshment Center.

Refreshment Centers configured for Refrigerated Food operation (see "**View Or Set Machine Configuration**" on page 64), will have electronic health shutoff control software. Health Shutoff Control software is required by state and local health authorities and is a requisite for NAMA approval for perishable food vending.

Health Shutoff Control prevents the merchandiser from vending product that could be spoiled. It monitors the temperature within the cabinet, and will automatically go into an out-of-service mode should any of the following conditions occur:

- The temperature of the refrigerated cabinet does not fall to 41° F (5° C) within 30 minutes after the door of the refrigerated cabinet is closed.
- The temperature of the refrigerated cabinet does not fall to 41° F (5° C) within 30 minutes after a defrost.
- The temperature of the cabinet rises above 41° F (5° C) for more than 15 minutes without the door of the refrigerated cabinet having been open, except within 30 minutes of a defrost.
- For testing purposes, the temperature of the cabinet rises above 41° F (5° C) for at least one second with the refrigerated door open.

When the health shutoff control is triggered, the display will read *TEMPORARY OUT OF SERVICE*, "*ONLY TOP 2 SHELVES AVAILABLE*" or "*ONLY TOP 3 SHELVES AVAILABLE*" depending on machine configuration. When the monetary door is opened, the message changes to *HC.ER*, and the date, time, and maximum cabinet temperature reached are displayed. If the refrigerated cabinet door is opened and then closed, the health control timer will reset and the refrigeration system will have another 30 minutes to cool the cabinet below 41° F (5° C).





The out-of-service condition may occur during initial setup, as it will take time for the refrigeration system to cool the cabinet the first time. Therefore, National Vendors recommends leaving the refrigerated compartment empty until the cabinet temperature is low enough to satisfy the health shutoff control.

Health Control will **not** be operative for Refreshment Centers configured for Chilled vending (see "**View Or Set Machine Configuration**" on page 64). Perishable food must only be sold from a merchandiser configured for Refrigerated Food operation. ***Vending perishable food from a chilled merchandiser will violate state and local health regulations.***

Test the Health Control

Use this procedure on model 480 merchandisers configured for refrigerated food to verify the operation of the Health Control Automatic Shutoff circuitry. The purpose of the Health Shutoff Control is to disable the vending mechanism whenever the machine does not maintain the air temperature in the food storage compartment at or below 41°F (5°C). The temperature shutoff requirement does not apply for 30 minutes after filling, servicing or a defrost cycle.

NOTES:

- a. The Automatic Health Shutoff Control timer resets every time the cabinet door is closed.
 - b. The internal cabinet temperature can be viewed on the credit display by pressing  .
1. Check the temperature of the food compartment by pressing  to ensure that the machine is not in the 30-minute recovery period that occurs after the door is closed following filling, servicing or after a defrost cycle. If the machine is in the 30-minute recovery period, the time remaining will appear on the display. Before proceeding, wait until the recovery period ends.
 2. Open the main door a minimum of 45 degrees to allow the food compartment temperature sensor to warm. Observe the cabinet temperature on the credit display by pressing the  button. When the temperature on the display rises to 42° F (5.5°C), the message "TEMPORARY OUT OF SERVICE", "ONLY TOP 2 SHELVES AVAILABLE" or "ONLY TOP 3 SHELVES AVAILABLE" depending on machine configuration will display. This verifies that the vending mechanism of the machine has been disabled as required. With the door open, the sensor temperature will typically reach 42° F (5.5°C) in less than 5 minutes.
 3. Press the  button and the message "HCER" (Health Control Error) will display. This is the message a service person would observe after opening the door.
 4. Close the main door. You may observe the recovery time and temperature by pressing  again.

Section 7: Final Installation

Move the merchandiser to its *final position*:

- Perform “Open the Rear Outlet Diffuser” on page 9 before placing the merchandiser into its final position.
- You can position this merchandiser anywhere in a bank of machines. It can even be placed on an end flush against a side wall.
- The merchandiser should be placed at least four inches away from the back wall (six inches if rear diffuser is not installed). This will provide adequate air circulation for the refrigeration unit.
- The merchandiser will operate more efficiently when placed in a shaded location.
- There should be enough room in front of the merchandiser for the door to move freely.

WARNING

This machine is only rated for installation in an indoor location.

Level the Merchandiser

1. Use a spirit level to adjust the legs until the cabinet is level from side to side and front to back.

NOTE

A slight slope from front to back will improve the draining of condensate from merchandisers with refrigerating units. When the merchandiser is part of a bank of machines, level it in reference to the other machines. After leveling is complete, check that the door operates easily.

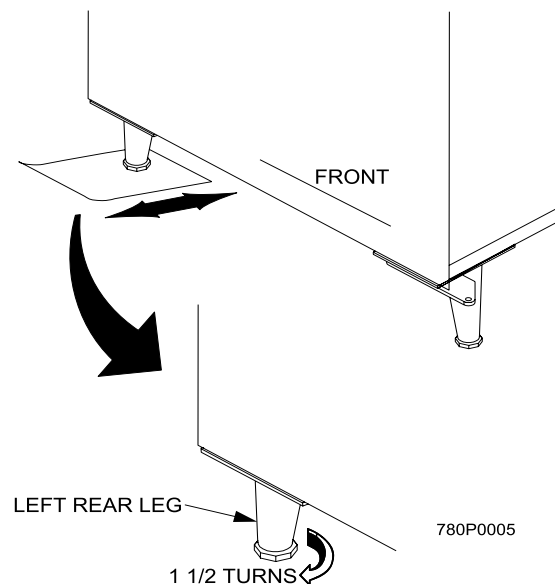
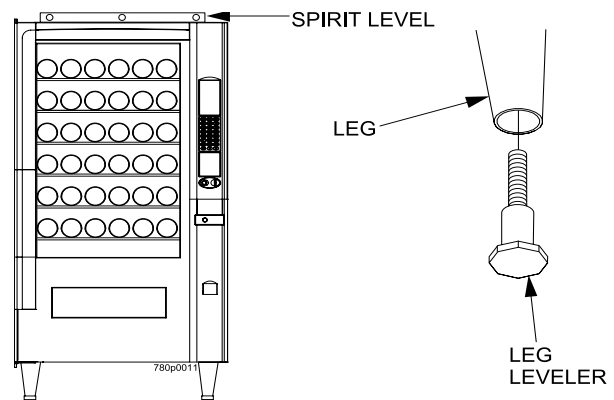

Install the Base Plate

Refer to the figure below while completing the following procedures:

WARNING

Do not move the cabinet while the hex head screws and/or carriage bolts are loosened. The cabinet would be unstable and could tip and cause injury.

1. Loosen the left leg assembly hex screws to allow mounting a base plate bracket.
2. Secure one of the base plate brackets to the leg assembly and tighten the hex screws.
3. Loosen the right leg assembly hex screws to allow mounting the other base plate bracket.
4. Secure the other base plate bracket to the right leg assembly using the two hex head screws. Tighten the hex head screws.
5. Insert the short arms of the slides into the hinged tabs of the base plate. Position the slide so the notch near the short arm is on the bottom side.
6. Insert the long arms of the slides into the base plate brackets.
7. Insert and secure a cotter pin through the hole in the back of each of the slides.
8. Push the base plate toward the merchandiser cabinet. The front tabs of the base plate brackets should seat in the notches in the long arms of the slides.

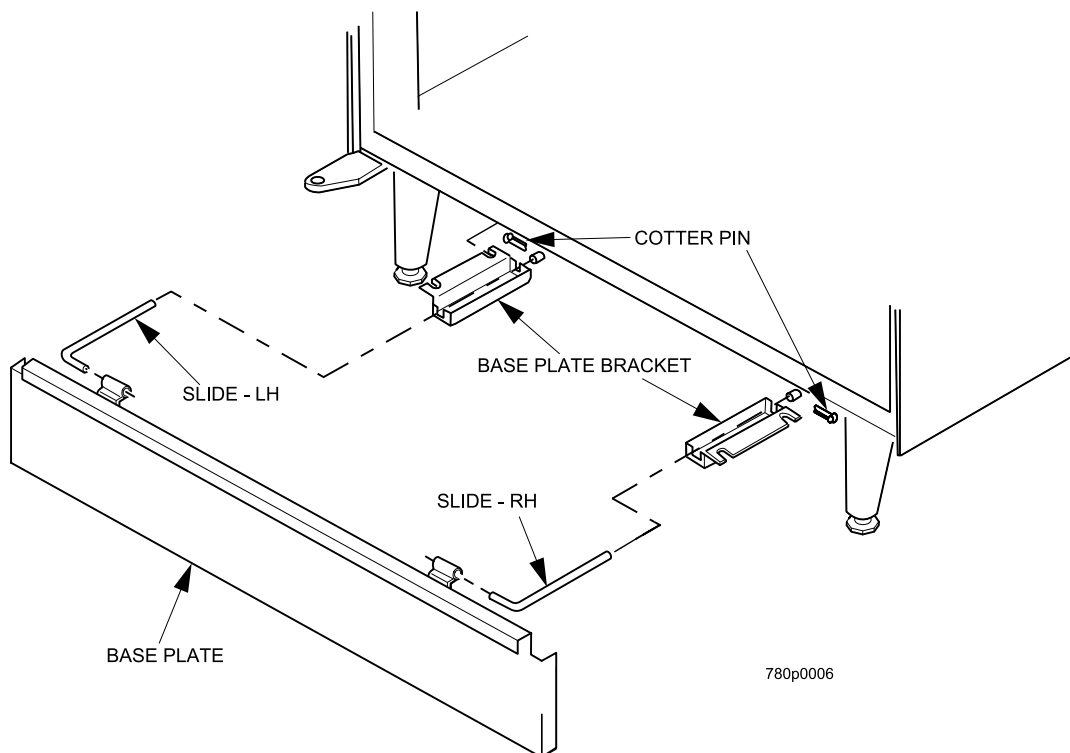

Install the Lock Cylinder

Install an optional lock cylinder in the merchandiser as follows:

1. Position the lift handle lock lever as shown.
2. Depress the lock spring at the square hole of the lock cylinder receptacle and pull the lock springs out through the front.
3. Position the lock cylinder as shown. Depress the spring loaded lock pin.
4. Push the cylinder into the cylinder receptacle in the lever. The pin should snap into the square hole.
5. If the cylinder pin does not seat in the square hole, press against both ends of the lock cylinder. Rotate the cylinder until the pin snaps into place.
6. **Leave the door open** and test the lock mechanism with a key. Do not close the door until you are certain the key will unlock the lock.

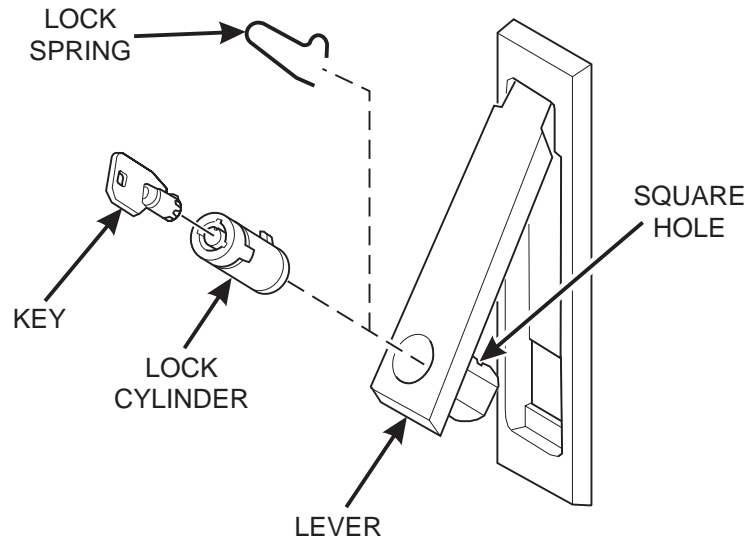

Install the Optional Cash Box Lock

Remove the cash box from the merchandiser.

1. Assemble the lock as shown in the illustration to the right.
2. Return the cash box to the merchandiser.

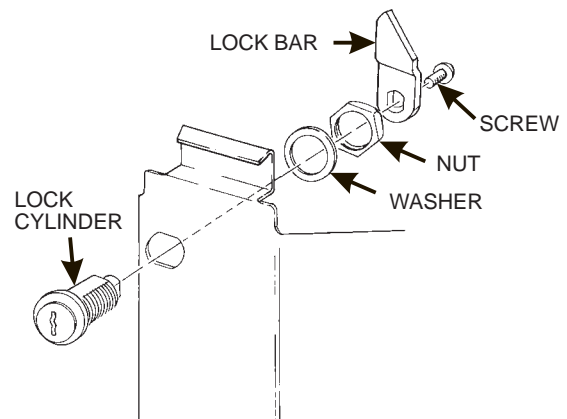

Set Up the Coin Mechanism

If the changer is not a MARS TRC 6000, proceed to **LOADING THE COIN MECHANISM**
 If the Changer is a MARS TRC 6000, you must set the high quarter switch.





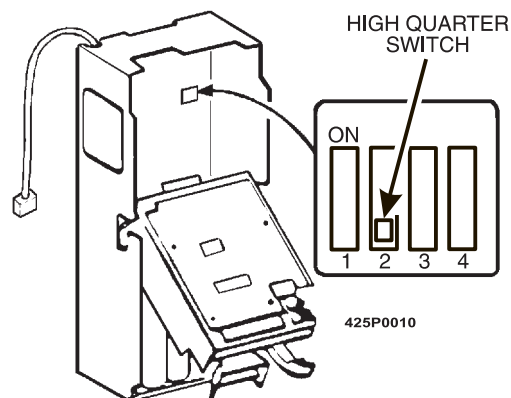

Set the Quarter Switch:

QUARTER SWITCH POSITION	ACTION
LOW	The coin mechanism will only store 6 quarters. The rest are sent to the coin box. Fewer quarters are available for change.
HIGH	The coin mechanism will store 69 quarters. More quarters are available for change.



Load the Coin Mechanism

Once you arrive at the steps that tell you how to setup your coin mechanism, please perform the following steps:

1. Plug the power cord into the electric outlet and turn ON the main power switch.
2. Press , and press  once. Press  until either *DUMB MECH* or *MDB MECH* displays (depending upon which coin mech type you have).
3. If you chose *MDB MECH* in the previous step, go to step 4 and perform the rest of this procedure. If you chose *DUMB MECH* in the previous step, fill the coin tubes with coins. Make sure the coins are not shingled. You are now finished setting up your coin mech. Do not perform the rest of this procedure.
4. Press  until the standby message is displayed, then press .
5. Insert at least 20 coins of each denomination through the coin chute. Continue to fill the coin tubes either through the coin chute or the tops of the tubes.
6. Visually check the coin tubes to make sure coins are not shingled.
7. Press .
8. If credit is still shown in the display, turn the machine power OFF, then back ON.

Operational Readiness Check

1. Perform test vends on all selections.
2. Do any of the snack or candy products catch on the tray and fail to vend? If not, skip to step 3. If so, perform the following procedures on the affected areas until all products vend properly:
 - a. Install and/or adjust a product spacer (See "**Install a Product Spacer**" on page 32).
 - b. Install a product pusher (See "**Product Pusher Usage**" on page 35).
 - c. Install and/or remove spiral wall retainers (See "**Spiral Wall Retainer Usage**" on page 34).
 - d. Perform the appropriate spiral anti-hang-up procedure(s).
3. Test the operation of the coin mechanism.
4. Test the operation of the bill validator.
5. Return all test vended products to the trays.

Spiral Indexing Procedure (One Spiral, One Motor)

The spiral indexing procedures involve rotating spirals one position at a time until the product vends properly.

1. Home all the motors.
2. Remove the effected spiral.
3. Is the coupler in the proper position?
NO - Move the coupler to the position as shown in "**Install a Gear**" on page 28. Go to step 4.
YES - Move the coupler to the next clockwise position (if it's on a right-hand motor), or the next counterclockwise position (if it's on a left-hand motor). Go to step 4.
4. Replace the spiral.
5. Perform a test vend (see the previous page).
6. Did the product hang up?
NO - You're finished. Continue to test vend the remaining selections until everything works right.
YES - Go to step 7.
7. Did you previously move the coupler to the next clockwise or counterclockwise position?
NO - Move the coupler to the next clockwise position (if it's on a right-hand motor), or the next counterclockwise position (if it's on a left-hand motor). Return to step 6.
YES - Return to step 2 in the operational readiness check and try another procedure. Do not move the coupler again.

Spiral Indexing Procedure (Two Spirals, One Or Two Motors)

The spiral indexing procedures involve rotating spirals one position at a time until the product vends properly.

1. Home all the motors.
2. Remove the left hand spiral of the affected pair.
3. Is the coupler in the proper position?
 - NO** - Move the coupler to the position as shown in "**Install a Gear**" on page 28. Go to step 4.
 - YES** - Move the left coupler to the next counterclockwise position. Go to step 4.
4. Replace the left hand spiral.
5. Remove the right hand spiral, spiral coupler, and gear (if used) of the affected pair as a unit.
6. Rotate this unit until the right hand spiral mirrors the position of the left hand spiral.
7. Replace the right hand spiral, spiral coupler, and gear (if used).
8. Perform a test vend (see the previous page).
9. Did the product hang up?
 - NO** - You're finished. Continue to test vend the remaining selections until everything works right.
 - YES** - Go to step 10.
10. Did you previously move the left hand coupler to the next counterclockwise position?
 - NO** - Remove the left hand spiral of the affected pair. Turn the left spiral coupler to the next counterclockwise position. Return to step 4.
 - YES** - Return to step 2 in the operational readiness check and try another procedure. Do not move the coupler again.

Test the Bill Validator

1. Insert a \$1 bill into the validator.
2. Push the coin return button.
 - THE BILL VALIDATOR IS IN THE ESCROW MODE** - No money is returned - you must make a selection in order to receive any change. Go to step 3.
 - THE BILL VALIDATOR IS NOT IN THE ESCROW MODE** - You should receive four quarters in change. Go to step 3.
3. Make a selection. The correct selection should be vended and correct change should be returned.

Section 8: Programming Intro

Some setup, test, and maintenance operations are computer controlled. The control panel switches and the selection panel switches regulate these operations.

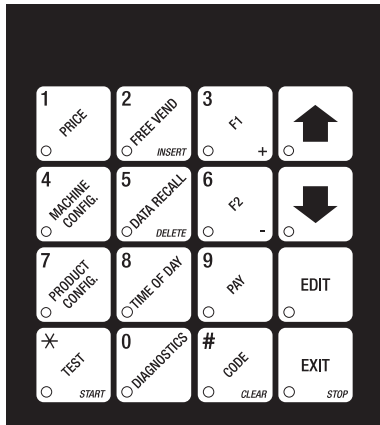

Control Panel

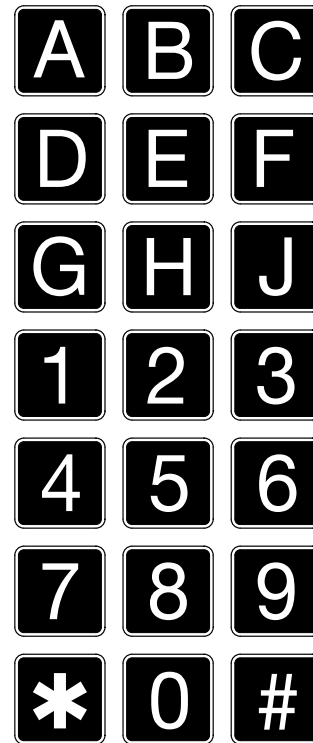

Selection Panel

157p0248

The Displays

The 10-character display performs two functions, and is referred to in this book as "the display":

1. It shows the customer's selection and how much credit is in the machine, as well as the ready, service, and time of day messages.
2. It provides information and feedback to the service person during maintenance.



The Function Keys

The keys on the control panel can have up to three functions:

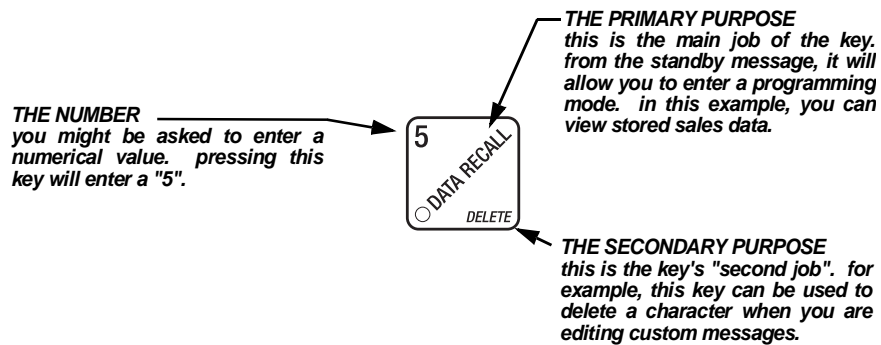

Other Keys

The MOVEMENT keys on the control panel let you move inside a mode, and back and forth between modes. To see how these keys let you move around, study the flow diagram on the next page.



The up and down arrow keys are your "legs", which let you move up and down the list of tasks. These keys are what let you continue from one step to the next in programming procedures.



This is your "activate" or "choose" key. It "opens a door" to additional information and lets you begin a programming task once you are inside of a mode. Sometimes, it is used as a toggle switch to show you your choices during a programming task.



This is your "end" key. Pressing it one or more times will move you back to the start of the mode, or all the way back to the standby message.

One Last Thing:

When you see the word CONTINUE at the end of a function, it means to press  until you return to the standby message.

Control Panel Switches Explained

Each of the control panel switches has one or more jobs to do. This list will give you a short overview of those jobs.



Press this button to put your machine into the Price Setting mode. You can see maximum and minimum machine prices, and change prices for entire machine, entire tray, or individual selection.



Press this button to set up how the Free Vend mode will operate.



Press to view the temperature of a cold unit (if applicable), or software version number.



Press this button to:

- Select display language
- Select coin mechanism and bill validator
- Select card reader and options
- Select monetary options
- Set winner feature



Press this button to:

- View total sales by machine, tray, or selection
- View total vends by machine, tray, or selection
- Clear resettable data
- View Winners
- View Time Data
- View or set machine I.D.



Press this button to:

- Download data into your portable data collection device (PDCD), **OR**
- Set printer baud rate, depending upon which device you are using



Press this button to:

- Set machine configuration
- Set which trays are active
- Set up SureVend™ options
- Set up can unit options
- Couple/uncouple tray motors
- Set cold unit temperature



Press this button to:

- Set time of day
- Set day, month, and year
- Set Daylight Savings Option
- Set time of day intervals for inhibit, freevend, and discount vending
- Edit messages
- Select display messages



Press this button to:

- Pay one or more coins from the coin mechanism.



Press this button to:

- See any fault or condition that has placed the machine out of service (see "**View Diagnostic Messages**" on page 91).



Press this button to:

- Perform test vends
- Test Motors
- Test machine functions
- Test displays



Press this button to:

- Enter the Supervisor mode
- Change Supervisor access code
- Lock/Unlock access to functions
- Set Printer or Dex Options
- Turn Talker Mode On/Off

Programming Flow Charts

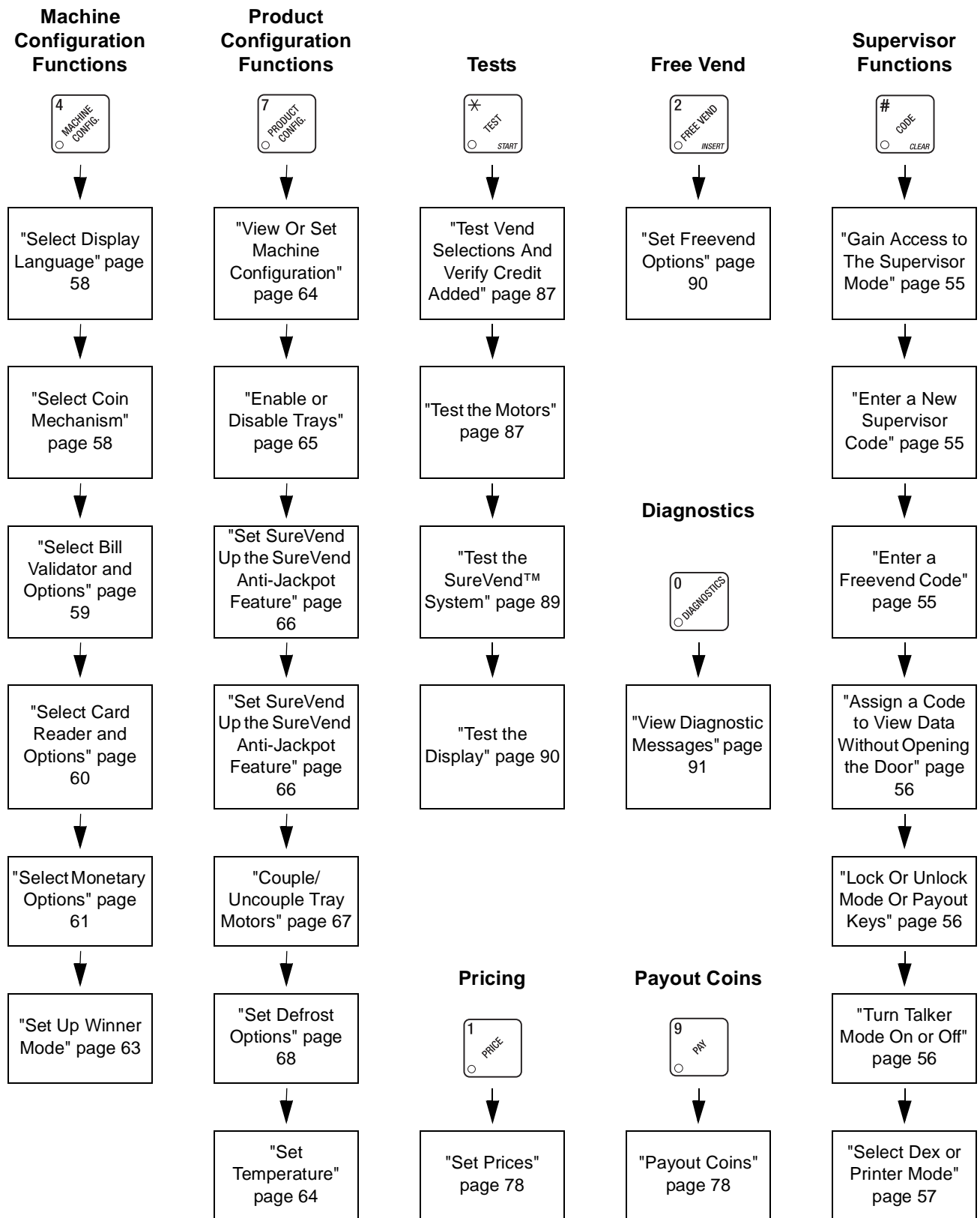

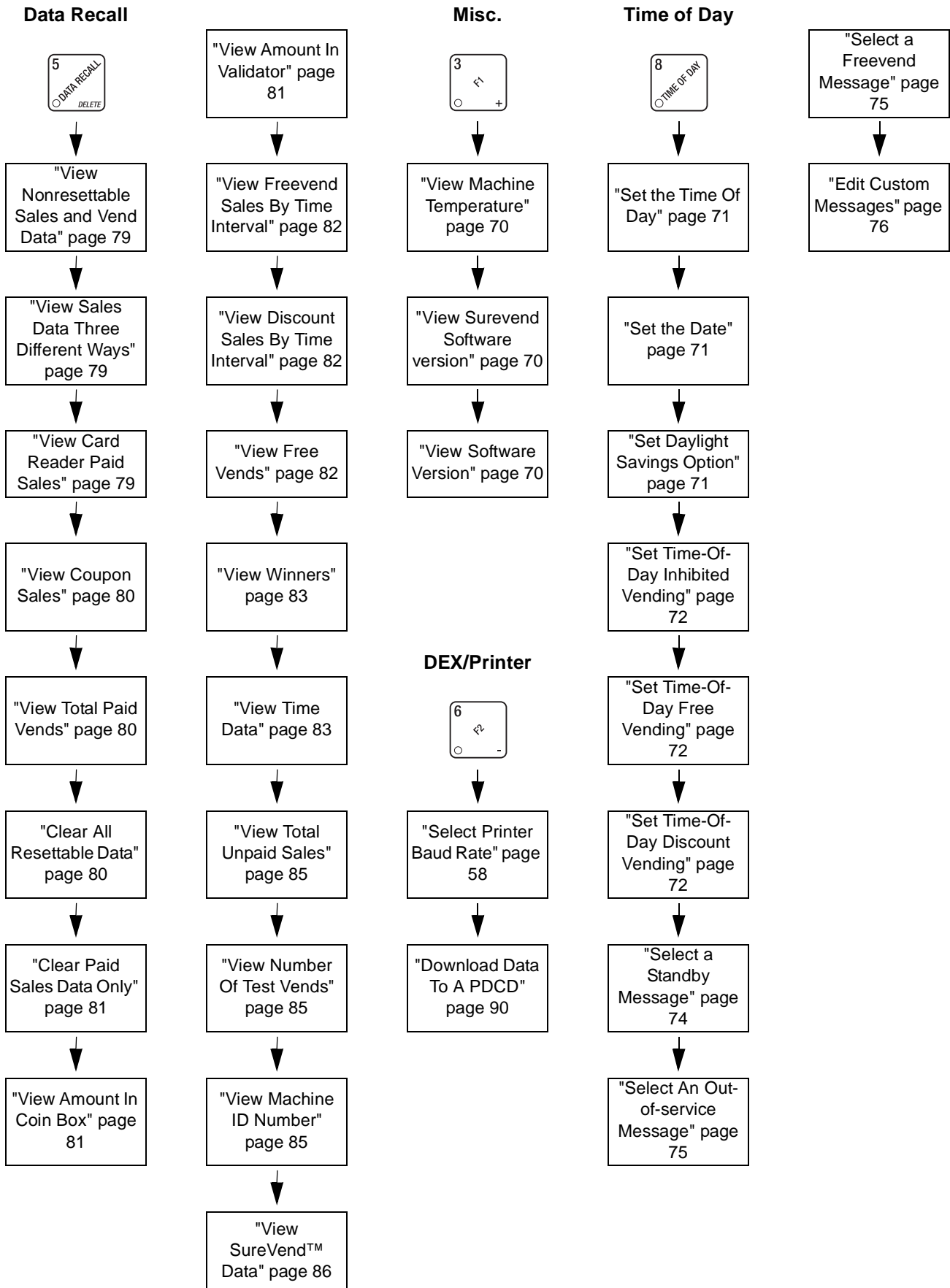



GAIN ACCESS TO THE SUPERVISOR MODE

1. Press . The display shows: *ENTER CODE*. You must enter the four-digit supervisor code within 6 seconds to gain access.



NOTE

A new machine has a factory-set supervisor code of 0000.

2. When you have entered the right code, you will hear two beeps and see *UNLOCKED* in the display. After a few moments, the standby message returns.
3. You are now ready to perform various supervisor functions.
4. CONTINUE.



ENTER A NEW SUPERVISOR CODE (Supervisor Mode Only)

1. Follow the steps in "**Gain Access to The Supervisor Mode**" on page 55.
2. Press , then  until the display shows *SUPER XXXX*. The X's represent the current supervisor code. Use the number keys to enter a new code.



IMPORTANT!

If you enter a new code, be sure to keep a written record of it. There is no other way to access the SUPERVISOR mode.

3. CONTINUE.





ENTER A FREEVEND CODE (Supervisor Mode Only)

1. Follow the steps in "**Gain Access to The Supervisor Mode**" on page 55.
2. Press , then  until the display shows *FREE XXXX*. The X's represent the current freevend code. Use the number keys to enter a new code. This code is used with the **FREE WITH KEY** freevend mode. If the code is anything other than "0000", it must be entered after the key lock is turned in order to enable one free vend.
3. CONTINUE.



**ASSIGN A CODE TO VIEW DATA WITHOUT OPENING THE DOOR
(Supervisor Mode Only)**

If the proper code is entered, sales data can be viewed by machine, tray, or selection without opening the merchandiser's door.

1. Follow the steps in "**Gain Access to The Supervisor Mode**" on page 55.
2. Press , then  until the display shows *NR XXXX*. The X's represent the currently entered code. Use the number keys to enter a new code, if desired.



Usage:

From the standby message, enter the code using the customer keypad. Non-resettable (total paid sales and total paid vends) will display. Press  to scroll through the data.

3. CONTINUE.



**LOCK OR UNLOCK MODE OR PAYOUT KEYS
(Supervisor Mode Only)**

1. Follow the steps in "**Gain Access to The Supervisor Mode**" on page 55.
2. Press , then  until the display shows either *#. LOCKED* or *#. UNLOCKED*. The pound sign (#) is the first mode key that can be locked or unlocked. To see if another key is locked or unlocked, press that key.
3. Press  to change between locked and unlocked. When anyone other than the supervisor tries to enter a locked mode, the display shows *LOCKED*.

NOTE



The following mode keys cannot be locked out:



4. CONTINUE.







**TURN TALKER MODE ON OR OFF
(Supervisor Mode Only)**

1. Follow the steps in "**Gain Access to The Supervisor Mode**" on page 55.
2. Press , then  until the display shows *TALK ON* or *TALK OFF*.
3. Press  to toggle between the two choices.
4. CONTINUE.





SELECT DEX OR PRINTER MODE (Supervisor Mode Only)

1. Follow the steps in "**Gain Access to The Supervisor Mode**" on page 55.
2. Press , then  until the display shows one of the following:
 - PRINTER* means that data will be sent directly to a printer,
 - DEX ONLY* means that data remains in memory after it is downloaded into a portable data collection device,
 - DEX +CLR* means that resettable data is cleared after it is downloaded into a portable data collection device.
 - DEX NR* a special DEX option. All sales data will become non-resettable. Consult your DEX supplier before choosing this option.
3. Press  to toggle through the choices. Press  to lock in the selected option.
4. CONTINUE.





SET DEX OPTIONS (Dex Mode Only)

1. Follow the steps in "**Gain Access to The Supervisor Mode**" on page 55.
2. Press , then . The display shows one of two resettable bill validator totals transmitted to the DEX device:
 - CA 304 - N.C.* - the value of bills in the stacker will be transmitted in a cash format. For example: **200** for two dollars. (This is the default setting.)
 - CA 304 - N.D.* - the value of bills in the stacker will be transmitted in a dollar count format. For example: **2** for two dollars.
3. Press  to switch between the two choices. Consult your DEX handheld supplier for the proper settings for your machine.



NOTE

If your bill count is incorrect, the CA304 setting may be wrong. Try using the other setting.



4. Press  until the display shows one of the following two date/time options:
 - LASTVND.ON* - DEX transmits the date and time of the last vend for each selection.
 - LASTVND.OFF* - DEX will **NOT** transmit the date and time of the last vend for each selection. (This is the default setting)
5. Press  to switch between the two choices.
6. CONTINUE.

**SELECT PRINTER BAUD RATE****(Printer Mode Only)****BAUD
RATE**



The speed of data transfer, expressed in bytes per second. Your printer can receive data at a certain rate, and you must tell the printer what that rate is.

1. Press . One of the following will display:
BAUD 1200, BAUD 2400, BAUD 4800, BAUD 9600
2. Press  until the correct baud rate for your printer is displayed.
3. CONTINUE.

**SELECT DISPLAY LANGUAGE**

1. Press . The current **LANGUAGE** is shown in the display. Press  to choose the desired language. Your choices are: *ENGLISH, DEUTSCH, FRANCAIS, ESPANOL, PORTUGUES, SWEDISH, NEDERLANDS, or FINNISH.*
2. CONTINUE.

**SELECT COIN MECHANISM**



1. Press , then press  until the current **COIN MECHANISM** is shown in the display. Press  to choose the desired coin mechanism. Your choices are:
DUMB MECH, MDB MECH, EXEC MECH, or NO MECH
2. Proceed to "**Select Monetary Options**" on page 61, to customize your coin mechanism choice.

NOTE

Depending upon your choice of coin mechanisms, some displays may not appear.

3. CONTINUE.

**SELECT BILL VALIDATOR AND OPTIONS**

1. Press , then press  until one of the following choices displays:

NO DBV

- No bills will be accepted or there is no bill validator installed (you can exit the function).

SER.1.2.5.10.20

- The serial bill validator is selected and will accept \$1, \$2, \$5, \$10, and \$20 bills. Use BILL SELECTION METHOD below to change the bills that will be accepted.

MDB.1.2.5.10.20

- A standard MDB bill validator is selected. It will accept \$1, \$2, \$5, \$10 and \$20 bills. Use BILL SELECTION METHOD below to change the bills that will be accepted.

PULSE DBV

- The pulse bill validator will accept \$1 bills.

MDB. ()*

- An MDB bill validator that accepts non-standard bills or tokens is

connected and operating. Press  to enter list of bills. **"Initial**

Setup of a Non-Standard Bill Validator" on page 60.

2. Press  to choose the desired option.

BILL SELECTION METHOD:

The standard \$1, \$2, \$5, \$10, and \$20 bills are enabled by pressing the 1, 2,

5, 6, or 7 key(s), respectively. Press  to select all denominations, press



to deselect all.

3. CONTINUE.



INITIAL SETUP OF A NON-STANDARD BILL VALIDATOR

1. Connect the bill validator, and follow the steps in "Select Bill Validator and Options" on page 59, to select *MDB.12.5.10.20* in the bill validator selection screens. *MDB:.<*>* will not be an option yet. Exit the bill validator setup by pressing . Bill information is now collected from the validator.
2. Press , then press until *MDB:.<*>* displays.
3. Press . *1 100 ON* will display. The first number (*1*) indicates bill validator channel 1, the *100* is the bill denomination, and *ON* indicates that the validator will accept \$1.00 bills.
4. Press to toggle the bill acceptance *ON* or *OFF*.
5. Press and to scroll through the list of other denominations and to set them to *ON* or *OFF*.
6. Press to move up to the top level screen.

NOTE

If a denomination does not display in the scroll list of available denominations, check the binary switch settings for the validator. If the binary switch for a given denomination is set to "off", it will not display in the list of denominations.

7. CONTINUE.



SELECT CARD READER AND OPTIONS

1. Press , then press until the current card reader shows in the display.
2. Press to cycle through the card reader options.

Your choices are: *NO CARD*, *DUMB CARD*, or *MOB CARD*.

NOTE

If you selected *NO CARD* you can exit the function.

3. Press until one of the following displays:
REVALUE.ON - Allows credit to be transferred onto the card
REVALUE.OFF - Credit cannot be transferred to the card
4. Press to display the desired choice.
5. CONTINUE.

**SELECT MONETARY OPTIONS**

This function lets you:

- Set declining balance,
- Set currency acceptance on low change,
- Set overbuy options,
- Set last bill stacking options

DECLINING BALANCE: Once credit is established, multiple vends may occur until the coin return is pressed.

1. Press , then press  until the display shows *CHANGE X.XX*.



X.XX represents the largest denomination coin or bill that will be changed without a purchase. Any non-zero value here will return all escrowed coins. (Each coin denomination for which the coin mech has a tube is called an **ESCROWED** coin because it can be returned.) When the coin return button is pressed, all coins inserted will be returned provided there is a coin mech tube for each of those coins, **EXCEPT** in the forced vend mode.

Some examples:

CHANGE 0.00 - Forced vend; NO change returned without a purchase.

CHANGE .25 - Returns change without purchase if all accepted coins are less than .25 denomination or have a payout tube. Acceptance of a dollar coin will not cause a Force Vend if the coin mechanism has a dollar coin payout tube. Otherwise, accepting a dollar coin or accepting and stacking a dollar bill will cause a Force Vend.

CHANGE 1.00 - Bills and non-escrowed coins less than or equal to \$1.00 will be changed without purchase. All escrowed coins are returned.

2. Press  to display the desired choice.
3. Press  until one of the following displays:

ACC <\$\$ X.XX -Accept any bill of value \$X.XX or less. Hold the last bill that meets or exceeds maximum price in escrow.

OR

ACC.STK X.XX -Accept any bill of value \$X.XX or less. Immediately stack the last bill.

Example: If setting is *ACC.STK 1.00* and maximum price is \$1.50. This setting will immediately stack the second \$1.00 bill inserted.

4. Press  to display the desired choice.

5. The value of "X.XX" has two purposes:
- It tells the machine how large a bill or coin to accept even though there is not enough change in the coin mech to cover all possible paybacks.

For example, enter 1.00. The machine will take a dollar bill or coin even though there is less than \$1.00's worth of change. Entering 5.00 tells the machine to take a five even though there is less than \$5.00's worth of change, and so forth.

NOTE

This could cause a customer to be short-changed.

Entering **0.00** means that bills or coins will only be accepted if there is enough change to cover them.

- The value of "X.XX" also tells the machine how much the customer is allowed to overbuy a product. The customer will be short-changed when an overbuy occurs.

Example:

For a value of \$0.25: if there is no change in the machine and the customer inserts a \$1.00 bill. The customer can purchase a product for \$0.75 even though the change cannot be paid back. The customer will be short-changed. Normally a purchase will not be approved unless all change can be paid.

Entering 0.00 means that the vend will only be approved when the correct change can be returned (overbuy disabled).

6. Press  until the display shows: *LOW.MSG X.XX*. The display will show *USE EXACT CHANGE* when the amount of available change in the coin mechanism falls below the value of "X.XX". Enter a value with the number keys. For example, if *LOW.MSG 100* is displayed, the *USE EXACT CHANGE* message is displayed when less than a dollar's worth of change is in the coin mechanism.

7. Press  until one of the following displays:
- DECLINE.ON* - More than one vend is allowed, with a declining balance.
DECLINE.OFF - A declining balance is not allowed.





8. Press  until one of the following displays:
- FAIL - CASH* - This means that the customer will automatically receive a refund if the vend fails.
FAIL - CRDT - This means that the customer's credit is restored to the machine if the vend fails, allowing another selection to be made. Additionally, the customer can press the coin return to receive a cash refund.

9. Press  to display the desired choice.

10. CONTINUE.

**SET UP WINNER MODE****WINNER**

At preselected intervals, a customer may receive a refund for a selection. You can select the intervals and qualifying selections.

1. Press , then press  until one of the following displays:
WINNER OFF Winner function is disabled.
-or-
WIN XXXX Winners are allowed at certain intervals, represented by "XXXX".
2. Press  to display the desired choice.
3. If you selected *WINNER OFF*, you can exit the function.
4. The display shows *WIN XXXX*. XXXX represents the number of vends that must occur per each winner vend. For example, an interval of 50 means that a winner can happen any one time during the next 50 vends. Using the number keys, enter an interval between 10 and 9999.
5. Press . The display shows *----- . The dashes in the display represent which trays are allowed winners. Press the appropriate letter key to enable a tray, press the key again to disable it. For example, pressing A, C, and E will cause the display to look like this: *A - C - E - - - -*, meaning that all A, C, and E selections can have a winner.

ADVANCED OPTIONS:

Press  to enable all trays.

Press  to deactivate all trays.

AN EXAMPLE . . .

You want to enable winners on all trays except E and F. Do the following:

- a. Press . The letters *A* through *F* display instead of the dashes.
- b. Press "E" and "F". The letters *E* and *F* in the display are replaced by dashes.
6. You can also enable individual selections by entering a number first (only by the customer keypad) then enter the tray or trays that you would like to enable.
7. CONTINUE.



VIEW OR SET MACHINE CONFIGURATION

(This function may be viewed at any time, but can only be set while in supervisor mode.)

1. Follow the steps in "**Gain Access to The Supervisor Mode**" on page 55.

2. Press . One of the following displays:

1. ALL FOOD HLTH.CTL ON Refrigerated food machine - health control will be operational

2. DUAL ZONE HLTH.CTL ON EXCEPT AB Refrigerated food machine - health control will be operational except trays A and B (this is a two tray configuration).

3. DUAL ZONE HLTH.CTL ON EXCEPT ABC Refrigerated food machine - health control will be operational except trays A, B, and C (this is a three tray configuration).

4. ALL NON-PERISHABLE NO HLTH.CTL Refrigerated food machine - health control will not be operational.

NON-PERISHABLE FOOD ONLY!

3. Press  until the appropriate configuration for your machine displays.

Caution:

Dual zone configuration #2 and #3 should only be selected when the machine is configured in dual zone as described above.

(See "Configure Machine for Dual Zone" on page 10)

BE CAREFUL when you select your configuration, because selecting the wrong one will affect other choices later on, and could cause problems.



4. CONTINUE.





SET TEMPERATURE

(Supervisor Mode Only)

1. Follow the steps in "**Gain Access to The Supervisor Mode**" on page 55.

2. Press , then press  until the display shows +/- *+38°F*. This means that *38°F* is the current temperature setting.



3. Press  to raise the setting; press  to lower the setting.

For health controlled machines, the temperature setting can range from 36° - 38°F (2° - 3°C). Factory default is 38° F.

For non-health controlled machines, the temperature setting can range from 36° - 74°F (2° - 23°C). Factory default is +38°F.

4. Press  to choose between display in °F or °C.
 5. CONTINUE.
-

**ENABLE OR DISABLE TRAYS**

1. Press , then press  until the display shows something similar to:
A.B.C.D.E.F This display means that all trays (A - H) are available for vending. An unavailable tray has its letter replaced by a blank space.
2. Press the appropriate letter to toggle a tray on or off.

NOTE





Unavailable selections will not appear in the diagnostics.

3. CONTINUE.



SET UP BASIC SUREVEND™ OPTIONS



The SureVend™ system uses infrared sensors to ensure that a vend is successful. See "SureVend™" on page 41 for a fuller description of its features before performing the configuration procedures below.

1. Press , then press  until the display shows one of the following:
SURE.V OFF. Choose this option if you do not want to use the SureVend™ feature.
SURE.V ON. The SureVend™ option is activated.
2. Press  to choose between these options. If you chose *SURE.V OFF*, you are finished with all SureVend™ functions. Otherwise, continue to the next step.
3. Press  until the display shows one of the following:
OPT'N SURE.V. If the SureVend™ system has any kind of a failure, the machine will revert to its normal operating mode, bypassing the SureVend™ feature.
MUST SURE.V. If the SureVend™ system has any kind of failure, the machine will go temporarily out-of-service until the fault is corrected.
4. CONTINUE.



SET SUREVEND UP THE SUREVEND ANTI-JACKPOT FEATURE

The programmable anti-jackpot mode protects against unforeseeable cheating of the SureVend™ system by certain forms of tampering. A SureVend™ empty condition occurs when delivery of the product is not detected, and the customer's money is restored or returned. If a certain (user programmable) number of empty conditions occur, the machine will either revert to normal vending or go out of service (depending upon whether you selected *OPT'N SURE.V* or *MUST SURE.V* above). This condition will remain for a set number of minutes to discourage a possible thief from remaining near the machine.





1. Press , then press  until the display shows *ANTI.JP @ XX*.
 XX represents the number of empty conditions that will occur before the SureVend™ system is disabled for a certain number of minutes.
2. Enter the number of empty conditions using the number keys. (Entering **00** disables this feature.)
3. Press . The display shows *A.J.P.T.M.R XXM*.
 XX represents the number of minutes the SureVend™ system remains disabled after an anti-jackpot occurrence.
4. Enter the number of minutes using the number keys. (Entering **99** causes the SureVend™ system to remain disabled until the main door is closed after the next service call.)
5. CONTINUE.

**COUPLE/UNCUPLE TRAY MOTORS**

Two motors may be electronically coupled to turn together to vend a wide product. In some cases, you may need to connect or disconnect the wire harness from a specific motor. See "**Set Up A Tray To Vend Wide Products**" on page 18.

NOTE:

An even numbered motor (0, 2, 4, etc.) may only be coupled to an odd numbered motor (1, 3, 5, etc.)

1. Press , then press  until the display shows *CPL MTRS.*
2. Press the letter of the tray you want to couple, or press  to couple motors on tray A, then press  to get to the desired tray.

COUPLE ADJACENT MOTORS:

- a. The display shows *+A.+A.+A.+A.+A.*. This display means that on the A tray, all adjacent motors (0 and 1, 2 and 3, etc.) are coupled.

NOTE:

The +s and As represent motor positions 0 through 9.

- b. On the control panel, press the EVEN motor number of the pair you wish to couple or uncouple. In our example, to uncouple motors 0 and 1, press 0. The display will now show *A.A.+A.+A.+A.+A.*

COUPLE NON-ADJACENT MOTORS:

- a. Disconnect the motor(s) between the two you want to couple. See "**Connect and Disconnect a Motor Harness**" on page 24 for information on how to do this. The display shows *A.A.+ A.+A.+A.*. This display means that on the A tray, adjacent motors 0 and 1 are NOT coupled, 2 is coupled to 5, 6 is coupled to 7, and 8 is coupled to 9.

NOTE:

The +s and As represent motor positions 0 through 9. If a motor is disconnected or not present (motors 3 and 4 in this example), its position is replaced by an empty space.



- b. On the control panel, press the motor number of the even motor of the motor pair you wish to couple or uncouple. For example, to uncouple motors 2 and 5, press 2. The + representing motor number 2 changes to a C. Please note that the left motor of a coupled pair **MUST** be an even-numbered motor.
3. CONTINUE.





**SET DEFROST OPTIONS
(Supervisor Mode Only)**



The Refreshment Center has a built-in defrost cycle to assure that ice does not build up on the evaporator coil. It may be necessary to adjust the defrost timing for locations with extremely warm and humid conditions (see unscheduled defrosts below).

1. Follow the steps in "**Gain Access to The Supervisor Mode**" on page 55.

2. Press , then  until the display shows *SETDEFROST*.

3. Press . The display will show *X/DAY*. "X" is the number of times per day that the defrost cycle operates. This can be set for 2, 3, or 4 times per day, with a default of 2.

Press  to change the value of X.

4. Press  until the display shows *FOR XXMIN*. XX represents how many minutes the defrost cycle operates. The default value is 10 minutes, but this value can be configured between 10-15 minutes. Press  to change the value of XX.

5. Press  until something like the following displays:

2 > NORM SINCE 2003 07/08 04.28

2 > NORM is a running total of the number of **Unscheduled Defrosts** the compressor has performed since July 8 at 4:28. The time is in 24 hour format.

The controller monitors the compressor operation and may determine that a defrost cycle is necessary in addition to the regularly scheduled defrost. If more than 3 unscheduled defrosts occur per month, check that the door seals properly. If no air leak is apparent, the scheduled defrost cycle can be increased in rate or duration as in steps 2 and 3 above.

6. If desired, press  to reset the counter to 0 and the counter date and time to the present.

7. CONTINUE.





SET FIRST IN - FIRST OUT(FIFO) MODE

FIFO is used to link adjacent selections together to act as a single selection. The selections will alternate delivery between the linked selections no matter which of the selections are actually made. This assures that when the same product is offered in multiple selections the freshest product is delivered. Any selection can be set up in the FIFO mode, however you cannot link motors on other trays. FIFO does not work in the test vend mode.

NOTE:

All spirals in FIFO must be full of product from front to back to prevent false anti-jackpot errors.



1. Press , then  until the display shows *FIFO MTRS*
2. Press the letter of the tray you want to link, or press  to link motors on tray A, then press down until desired tray.
3. The display shows *AAAAAAAAAA*. This display means that on the A tray, no adjacent motors are linked.
4. Press the selection number to toggle that motor of the tray between FIFO and no FIFO.

NOTE:



Fifo motors are shown as ">" in place of the tray letter in the motor position. The ">" means that this motor is linked to the motor to the right. For coupled motors, the even motor will show + and the odd motor will show ">". The last motor on a tray cannot have a ">". A "?" is displayed if a motor was originally marked as FIFO but now is not present. A "X" is displayed if the motor is FIFO linked but not present. A "O" is displayed if the motor is the last of a FIFO link but not present.

EXAMPLE:

The display shows tray A as *AAA>>AAAAA*. The display is telling you that selctions A2, A3, and A4 are all linked together and are using the FIFO mode.

5. Press  to link the whole tray together.
6. Press  to unlink all motors on a tray.
7. CONTINUE.

**SHOW THE TEMPERATURE IN STANDBY MODE****(Supervisor Mode Only)**

1. Follow the steps in "**Gain Access to The Supervisor Mode**" on page 55.
2. Press , then  until something like +/- +37°F displays.
3. Press  an apostrophe is added before the temperature +/- '+37°F. Close the door. The temperature will display in the ready message once the temperature setpoint is met.
4. CONTINUE.

**VIEW MACHINE TEMPERATURE**



1. Press . The display shows *TEMP +38°F*. This example shows that the machine temperature is 38° degrees Fahrenheit.

NOTE



The temperature reading may display one of the following instead of "TEMP", depending on conditions in the machine:

- XX.H* - XX is the number of minutes left in the health control grace period (see "**Health Control**" on page 42)
 - HC.ER* - a health control error has occurred.
 - DEF* - the machine is currently in a passive defrost cycle
 - +*X.X* - the temperature has been over the health control limit for x.x minutes.
2. If "!" replaces "F" or "C" after the temperature, then the temperature is invalid. The last valid temperature is shown. Check diagnostics for the cause, usually a faulty sensor.
 3. A decimal point following "F" or "C" indicates the software has turned the compressor on. If the compressor is not on, check the related wiring.
 4. A comma after the "F" or "C" indicates the software is currently performing a defrost.
 5. To change the display units, press . The display now shows *TEMP +03 °C*.
 6. CONTINUE.

**VIEW SUREVEND SOFTWARE VERSION**

1. Press , and press  until the display shows *SURE VER XXX*. "XXX" represents the current SureVend software version number.
2. CONTINUE.

**VIEW SOFTWARE VERSION**

1. Press , and press  until the display shows *VER XXX.XX*. "XXX.XX" represents the current software version number.
2. CONTINUE.

**SET THE TIME OF DAY**



1. Press . The display shows *TIME HH.MM*. "HH.MM" is the time in 24-hour format.
2. Enter the current time using the number keys.

NOTE

9:00 am is entered with a leading zero: 0900; 9:00 pm is entered as 2100.



3. CONTINUE.

**SET THE DATE**

1. Press , and press  until the display shows *MM/DD/YY X*. "MM" is the month, "DD" is the day, "YY" is the year, and "X" is the numbered day of the week (1=sunday, 2=monday, etc).
2. Enter the current day, month, and year using the number keys. The day of the week number will be calculated for you based on the date you enter. For example, press the following keys to enter January 22, 2004: **0, 1, 2, 2, 0, 4**. While you are doing this, the "X" character becomes a dash (-) until you have finished entering the day, month, and year. Don't enter that day of the week number yourself.
3. Press  to switch between MM/DD/YY and MM-DD-YY formats.
4. CONTINUE.



**SET DAYLIGHT SAVINGS OPTION**

This option will automatically adjust the machine's clock for daylight savings.

1. Press , and press  until the display shows one of the following:
DST N.AMER, DST UK/EUR., DST AUSLIA, DST OFF
2. Press  to select the appropriate option for your machine.
3. CONTINUE.



**SET TIME-OF-DAY INHIBITED VENDING**

You can configure up to four inhibited intervals per day.

1. Press , then press  until the display shows *INHIB* - - - - .
2. Go to "**Time Interval Editing**" on page 72 for an example of how to set up time-of-day inhibited vending.



**SET TIME-OF-DAY FREE VENDING**

You can configure up to four Free Vend intervals per day.

1. Press , then press  until the display shows *FREEV* - - - - .
2. Go to "**Time Interval Editing**" on page 72 for an example of how to set up time-of-day free vending.

**SET TIME-OF-DAY DISCOUNT VENDING**

Vending can be discounted up to four times a day. For example, this can be used to favor early-arriving employees.

1. Press , then press  until the display shows *DISCT* - - - - .
2. Go to "**Time Interval Editing**" on page 72 for an example of how to set up time-of-day discount vending

**TIME INTERVAL EDITING**

You can select up to four times of day for each special vending period.





NOTE

If two or more of these time periods overlap, the interval with the highest priority will overrule the other(s). This order of precedence is:

- a. INHIBIT
- b. FREEVEND
- c. DISCOUNT

For example, if a DISCOUNT time period is scheduled for a certain area before the end of an INHIBIT time period, DISCOUNT does not begin until the INHIBIT interval has ended for that area.





The time interval editing procedure is almost the same for the INHIBIT, FREEVEND, and DISCOUNT intervals. There is one difference for the DISCOUNT time interval, so we will use it in our example. Assume you just finished "**Set Time-Of-Day Discount Vending**" on page 72. Step 1 picks up where you left off . . .

1. Press , then press  until the display shows *DISCT - - - -*.
2. Press the number of the time interval you want to edit, or  to edit time interval 1 (we'll use interval 1 for this example).
3. The display shows *IDISCT ON* or *IDISCT OFF*. This tells you whether your time interval (represented by 1) is on or off. Press  to change the condition of the time interval.



NOTE



If you turn an interval ON, it must be edited.

You can edit a time interval now, then turn it OFF until another time.

4. Press . The display shows *IDISCT X*. "X" represents the discount percentage for this period. Enter a discount percentage of 25 with the number keys. (Discount percentages of from 0 to 99 are permitted.) The machine will apply a 25% discount to each price, rounding up to the nearest nickel (or whatever is the smallest coin accepted by the coin mechanism).
5. Press . The display shows *ISTRT X.XX*. "X.XX" is the currently set start time. Enter a new start time (24-hour format) for this interval. To enter the time for 3:30 pm, enter 1530.
6. Press . The display shows *ISTOP X.XX*. "X.XX" is the currently set stop time. Enter a new stop time (24-hour format) for this interval. To enter the time for 6:00 pm, enter 1800. You have now established a 25% discount that starts at 3:30 pm and ends at 6:00 pm.
7. Press . The display shows *!@ - - - - - - -*. The dashes represent the days that this time interval is active. Pressing number keys 1 through 7 switches the days on/off (1=sunday, 2=monday, etc.) For example, press "2", "4", and "6". The display now shows *!@ - M - W - F -*. This discount interval is only active on Monday, Wednesday, and Friday.

8. Press . The display shows *----- . The dashes represent the trays affected by this time interval. Press the appropriate letter key to enable a tray, press the key again to disable it. For example, pressing A, C, and E will cause the display to look like this: *A - C - E - - - -*, meaning that all A, C, and E selections are affected by this interval.

Press  to turn on all levels; press  to turn all levels off.



9. Press . The display shows *LMESG OFF* or *LMESG X*. "OFF" means there is no custom message selected, and "X" represents the custom message number set for this interval. Press the number key of the message (1 through 8) you want displayed. To edit this message, press  and follow the procedure given in "**Edit Custom Messages**" on page 76. Press 0 to turn the message OFF for this time interval.

10. CONTINUE.





SELECT A STANDBY MESSAGE



The standby message is displayed during normal vending periods where there are no out of service faults on the machine.

1. Press , then press  until the display shows *STANDBY XX*. "XX" represents the current message number selected for the standby message. Two dashes mean that the factory-set message is selected.
2. To select a message, just press the corresponding number (1 through 8). To display the factory-set message, press 0.
3. The selected message (except the factory-set message) can be edited. To do this, press  and follow the procedure given in "**Edit Custom Messages**" on page 76.
4. CONTINUE.

**SELECT AN OUT-OF-SERVICE MESSAGE**







1. Press , then press  until the display shows *SERVICE XX*. "XX" represents the current message number selected to display when the machine is out-of-service. Two dashes mean that the factory-set message is selected.
2. To select a message, just press the corresponding number (**1** through **8**). To display the factory-set message, press **0**.
3. The selected message (except the factory-set message) can be edited. To do this, press  and follow the procedure given in "**Edit Custom Messages**" on page 76.
4. CONTINUE.

**SELECT A FREEVEND MESSAGE**

1. Press , then press  until the display shows *FREE XX*. "XX" represents the current message number selected for the message that displays when the machine is in the freevend mode. Two dashes mean that the factory-set message is selected.
2. To select a message, just press the corresponding number (**1** through **8**). To display the factory-set message, press **0**.
3. The selected message (except the factory-set message) can be edited. To do this, press  and follow the procedure given in "**Edit Custom Messages**" on page 76.
4. CONTINUE.





EDIT CUSTOM MESSAGES

1. Press , and press  until the display shows *EDIT MSG X*. X is the number of a message (1-8). Press the number of the message you want to edit.
2. Press . The message text is displayed with the first character flashing.
3. To view the message, press . The message scrolls across the display. To stop the scrolling, press .
4. When the character you want to change is flashing, either enter it directly, or use  and  to step through the character set until the desired character is displayed. Use the arrow keys to highlight different characters. See the section on the next page for an explanation of special keys and the character set.

SHORTCUT

Instead of stepping through the whole character set to enter a letter that is not on your keypad, enter one close to the one you want, then step to it.

Example: If you want to enter an **L**, first press , then press  six times. Your **L** should now be displayed.













THE END OF MESSAGE CHARACTER

This is the most important character in your message, because it tells the machine when the message is ended. If you don't use this character, your message will be followed by a bunch of zeros.



ENTERING YOUR MESSAGE

Most of the keys on the control panel have a special purpose to help you create and edit your messages:

- 
Inserts an **R** at the flashing character.
- 
Inserts a space at the flashing character.
- 
Inserts an **S** at the flashing character.
- 
Deletes the current character and closes up the space.
- 
Inserts a **T** at the flashing character.
- 
Deletes the current character and leaves the space.
- 
Repeats the letter to the left of the flashing character.
- 
Enters the special "end of message" character, which denotes the end of the message.
- 
"Pages" through the message, ten characters (one screen) at a time.
- 
Steps forward through the message, one character at a time.
- 
Steps backward through the message, one character at a time.
- 
Steps forward through the character list, one character at a time. See the character list on the next page.
- 
Steps backward through the character list, one character at a time. See the character list on the next page.

0	R	J	U	[
1	B	L	V]	
2	C	M	W	#	
3	D	N	X	P	
4	E	O	Y	+	
5	F	P	Z	-	>
6	G	Q	(SPACE)	/	?
7	H	R	-	.	@
8	I	S	\$	<	0
9	J	T	'	/	☒

**PAYOUT COINS**

1. Press . If a dumb mech was selected, the display shows *NDQ - 123*; if an MDB mech was selected the display shows *PAY 123*.
2. Press . A dumb mech pays out one *Nickel*; an MDB mech pays a coin from tube 1.
Press . A dumb mech pays out one *Dime*; an MDB mech pays a coin from tube 2.
Press . A dumb mech pays out one *Quarter*; an MDB mech pays a coin from tube 3.
3. To continuously pay out coins, hold down the appropriate key.
4. CONTINUE.

**SET PRICES**

1. Press . The display shows **** X.XX .YY** . X.XX is the highest price set for the machine, .YY is the lowest. Prices can be set from \$.01 to \$325.12. Enter prices using one of the following methods:

Set the Entire Machine to One Price

- a. Press . The display shows **** X.XX** . Enter a price using the number keys. All selections in the machine are now set to this price.



Set All Selections on a Tray to One Price

- a. Press the letter key (A - J) corresponding to the tray you want to price. The display shows **B* X.XX .YY** . This display shows the maximum (X.XX) and minimum (.YY) prices set for the B tray.
- b. Press . The display shows **B*** . Enter a price using the number keys. All selections on this tray are now set to this price.
- c. Press another letter key, or to price another tray.

Set the Price of an Individual Selection







- a. Press the number of the selection to be priced. (Example: B1.) The display shows **B1 X.XX** . Enter a price using the number keys. The selection is now priced.
- b. Press another letter key, or to price another selection.

**VIEW NONRESETTABLE SALES AND VEND DATA**

1. Press . The display shows *NR \$ XX.XX*. "XX.XX" is a dollar and cents figure showing the total of all sales in the machine. This is a running total, and is not resettable.
2. Press . The display shows *NR X*. "X" is the total number of vends made by the machine. This is a running total, and is not resettable.
3. CONTINUE.





**VIEW SALES DATA THREE DIFFERENT WAYS**

Paid sales and vends can be viewed three different ways: By whole machine, by tray, and by individual selection. The first screen of the data item shows its machine total.





1. Press , then press  until the display shows ***\$ X.XX*. This is the sales total for the machine.
2. To view the data by tray, press the letter of the tray you want to see. You can then press  and  to scroll through data for all the active trays.
3. To view the data by individual selection, press the letter and number of the selection you want to see. You can then press  and  to see data for all the active selections.
4. If viewing data by individual selection, press  to view the date and time of the last vend of that selection.
5. CONTINUE.

**VIEW CARD READER PAID SALES**







(Not shown if total is zero.)

1. Press , then press  until the display shows ***\$ XX.XX*.
2. Press , then press  until the display shows *DBT XX.XX*. "XX.XX" is the amount of money collected from card reader sales. Also, see "**View Discount Sales By Time Interval**" on page 82.
3. CONTINUE.



**VIEW COUPON SALES****(Not shown if total is zero.)**

1. Press , then press  until the display shows ****\$ XX.XX**.
2. Press , then press  until the display shows **TKN XX.XX**. "XX.XX" is the amount of money collected from card reader sales. Also, see "**View Discount Sales By Time Interval**" on page 82.
3. CONTINUE.



**VIEW TOTAL PAID VENDS**

1. Press , then press  until the display shows **** XX**. "XX" is the total number of paid vendes for the entire machine.
2. To view the data by tray, press the letter of the tray you want to see. You can then press  and  to scroll through data for all the active trays.
3. To view the data by individual selection, press the letter and number of the selection you want to see. You can then press  and  to see data for all the active selections.
4. CONTINUE.



**CLEAR ALL RESETTABLE DATA**

1. Press . The display shows **NR\$ XX.XX**. This is a running total, and is not resettable.
2. Press and hold . Two beeps sound and the display shows **CLEARING** momentarily, and then changes to **FINISHED**. All resettable data is cleared.
3. CONTINUE.





**CLEAR PAID SALES DATA ONLY**

1. Press , then press  until the display shows ****\$ XX.XX**. "XX.XX" is a dollar and cents figure showing the total of all PAID sales in the machine (as opposed to unpaid sales like winner and free vends). This is the total since the last time it was cleared.
2. Press and hold . Two beeps sound and the display shows *CLEARING* momentarily, and then changes to *FINISHED*. All paid sales data is cleared; other data is not cleared.
3. CONTINUE.





**VIEW AMOUNT IN COIN BOX
(Not shown if total is zero)**

1. Press , then press  until the display shows *CBX XX.XX*.
2. "XX.XX" is the dollar and cents amount in the coin box.
3. CONTINUE.





**VIEW AMOUNT IN VALIDATOR
(Not shown if total is zero)**

1. Press , then press  until the display shows *DBV XX.XX*. "XX.XX" is the dollar amount in the bill stacker.
2. Press  to show the quantities of bills in the stacker. For example, the display shows *\$0 | 20*, meaning that there are 20 \$1 bills in the bill stacker. Press  again to show the quantities of other bills, such as \$5s, \$10s, or \$20s.
3. CONTINUE.





**VIEW FREEVEND SALES BY TIME INTERVAL****(Not shown if total is zero)**

1. Press , then press  until the display shows *.0\$ XX.XX*.
XX.XX is the total value of unpaid vends.
2. Press , then press  until the display shows *IFRV .00*. This is the total sales for freevend interval 1, only shown if a freevend selection is made.
3. Press  to view freevend intervals 2 through 4.
4. CONTINUE.





**VIEW DISCOUNT SALES BY TIME INTERVAL****(Not shown if total is zero)**

1. Press , then press  until the display shows ***\$ XX.XX*.
2. Press , then press  until the display shows *IDSC .00*. This is the total sales for discount interval 1.
3. Press  to view intervals 2 through 4.
4. CONTINUE.

**VIEW FREE VENDS****(Not shown if total is zero)**

1. Press , then press  until the display shows *.0\$ XX.XX*.
2. Press , then press  until the display shows *FRV XX.XX*. "XX.XX" is the total machine-wide freevends, shown even if zero.
3. CONTINUE.

**VIEW WINNERS****(Not shown if total is zero)**

1. Press , then press  until the display shows *-0\$ XX.XX*.
2. Press , then press  until the display shows *WINN XX.XX*. "XX.XX" is the total machine-wide winners, shown even if zero.
3. CONTINUE.

**VIEW TIME DATA**

1. Press , then press  until the display shows *TIME DATA*.
2. Press . The following message scrolls across the display:

MAIN.1 237M 0 V30 10.13

This example shows the latest time interval the main (machine) door was open (1). It was open for **237** minutes, and was opened on January 30 (**01/30**) at 10:13 am (**10.13**).

Press . If applicable, similar displays will appear for intervals 2, 3, and 4.

Otherwise, go to the next step.

3. The following message scrolls across the display:

AUX.5 33M 0 V30 10.58

This example shows the latest time interval the interior door was open (5). It was open for **33** minutes, and was opened on January 30 (**01/30**) at 10:58 am (**10.58**). Press

. If applicable, similar displays will appear for intervals 6, 7, and 8. Otherwise, go to the next step.

4. The following message scrolls across the display:

HEALTH OFF 0 V30 14.09 MAX. 69 °F

This example shows that the health control timer turned off on January 30 (01/30) at 2:09 pm (14.09), and the maximum temperature reached was 69°F.

NOTE

The temperature display units will be in °C if you selected Celsius during the temperature display function.

5. The following message scrolls across the display:

LAST POWER 0 V30 13.51 FOR 00. 0.23

This example shows that the last time the machine lost power was on January 30 (**01/30**) at 1:51pm (**13.51**) for zero days, zero hours, and 23 minutes (**00. 0.23**).

6. Press . The following message scrolls across the display:

LONGST POWER 0 V30 10.58 FOR 00. 2.47

This example shows that the longest time the machine was without power was on January 30 (**01/30**) at 10:58am (**10.58**) for zero days, 2 hours 47 minutes (**00. 2.47**).

7. Press . The following message scrolls across the display:

FULL CLEAR 0 V30 8.58

This example shows that the last time resettable sales was fully cleared was on January 30 (**01/30**) at 8:58am (**8.58**).

8. Press . The following message scrolls across the display:

TIME SET 0 V30 9.15

This example shows that the last time the time or date was set was on January 30 (**01/30**) at 9:15 am (**9.15**).

9. Press . The following message scrolls across the display:

PRICE SET 0 V30 9.42

This shows that the last time prices were set was January 30 (**01/30**) at 9:42 am (**9.42**).

10. Press . The following message scrolls across the display:

LASTVND C1 06/02 9.42

This example shows that the last selection vended was C1 (**C1**) on June 2 (**06/02**) at 9:42 am (**9.42**).

11. CONTINUE.

NOTE

Refer to "**View Sales Data Three Different Ways**" on page 79 to view the date and time of the last vend of that selection.

**VIEW TOTAL UNPAID SALES****(Not shown if total is zero)**

1. Press , then press  until the display shows *.00* *XX.XX*.

"XX.XX" is the total unpaid sales (free vends, winner vends, 100% discounts, zero price vends) for the entire machine.

2. If desired, view this data by tray and individual selection.
3. CONTINUE.

**VIEW TOTAL UNPAID VENDS****(Not shown if total is zero)**

1. Press , then press  until the display shows *.0* *XX*.

"XX" is the total number of unpaid vends for the entire machine.

2. If desired, view this data by tray and individual selection.
3. CONTINUE.

**VIEW NUMBER OF TEST VENDS****(Not shown if total is zero)**

1. Press , then press  until the display shows *TST* *X*.

"X" is the number of test vends.

2. If desired, view this data by tray and individual selection.
3. CONTINUE.

**VIEW MACHINE ID NUMBER**

1. Press , then press  or  until the display shows *I.D.* *XXXXXX* .



The X's represent the 8-digit machine ID number.



2. You can edit the machine ID number if the SUPERVISOR access code has been previously entered.
3. CONTINUE.



VIEW SUREVEND™ DATA

Certain SureVend™ data can be viewed if the values are not zero.



1. Press , then press  until the display shows *SUREEMPT XXXX*. XXXX represents the number of times credit was restored or returned because of SureVend™. Press  to reset this count.

2. Press . The display shows ***SURE XXXX*. XXXX represents the total number of SureVend™ corrected vends, viewable by selection. These are vends which normally would not have delivered product if SureVend™ was not in use. Press and hold  to reset this count.

- a. Enter a selection letter/number to view the count for that selection.
- b. Either enter another selection letter/number, or press  to scroll through all selections.

NOTE

A high number of corrected vends on a specific selection could indicate that the tray is not properly configured for that product.

3. Press . The display shows *WO.SURE XXXX*. XXXX represents the total number of vends, viewable by selection, made while SureVend™ was not in use. Press and hold  to reset this count.
 - a. Enter a selection letter/number to view the count for that selection.
 - b. Either enter another selection letter/number, or press  to scroll through all selections.
4. CONTINUE.

**TEST VEND SELECTIONS AND VERIFY CREDIT ADDED**





1. Press . The display shows *TEST .00*. You may now test vend selections. If you insert money into the machine, the zeros in the display will be replaced with the amount of the credit. After the item vends, your money will be returned.

NOTE

You may make one more test vend if you close the door while still in TEST VEND mode.

2. CONTINUE.

**TEST THE MOTORS**

1. Press , then press  until the display shows *TEST MTRS.*
2. Press  to interrogate all motors. The display stops at the first motor with a known error, or will show the total number of homed motors.
3. Press  to run all snack motors one time. The display stops at any motor showing an error.

-or-

Press  to run only those motors not home or jammed. After a motor is run, an error message will show if any motors are still jammed or not home.

ERROR MESSAGES

DISPLAY	PROBABLE CAUSE
<i>QUK.CYCL.ID</i>	The motor (designated by its id number) cycles through its positions too quickly; it is probably shorted.
<i>CPL.ERR.ID</i>	An unresolved electronically coupled motor (designated by its id number).
<i>TEST ID</i>	The motor failed (designated by its id number), test it individually.
<i>TIMEOUT ID</i>	The motor (designated by its id number) did not leave home or reach home in the expected time; possibly jammed.

4. CONTINUE.



VIEW MOTOR STATUS BY TRAY

1. Press , then press  until the display shows *TEST MTRS.*

2. Press  or the letter of the tray you want to view.

3. The display will show the status of all motors on the tray:

- X (If motor is present) X is the tray letter being viewed
- + (If motor is present and coupled to the next odd motor)
- (blank) (If motor is not present and not coupled)
- ? (If motor is coupled but not present)
- .
- ' (If there is a motor error such as jammed, tray not detected or missing)

The following example is for tray C with 7 motors present and home with none jammed. Motors 1 and 3 are not present, 6 and 7 are coupled, and 8 is coupled to 9 but is not present nor home:

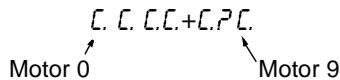

4. Press  to run all motors on this tray.

-or-

Press  to run only those motors in error.



-or-

Press a number key to run that motor only.

5. CONTINUE.



TEST THE SUREVEND™ SYSTEM

1. Press , then press  until the display shows one of the following:

SURETST OK This means the SureVend™ system is operating properly.

SURETST XX XX represents the location of a blockage. The sensing zone numbers 1 - 9 may appear (1 being closest to the glass). This display changes as the location of the blockage changes, accompanied by a beep. You may use this screen to test the product coverage of the SureVend™ sensors, but the accuracy may be somewhat lower than in actual vend situations.

SURETST CAL This means that calibration values are high. Press  to view the calibration values. This condition may be caused by dirt, misalignment of the SureVend™ sensors, or a partial blockage of a sensor.

2. From any of the previous displays, press  to view the real-time calibration values.

Press  to return to the *SURETST* screen.

A calibration value of 0 indicates a shorted detector. This will normally require replacing the hinge-side PC assembly.

A calibration value of 1 means that the zone could not be calibrated, indicating a blocked or damaged sensor.





Calibration values above A are abnormal and may require adjusting the alignment or cleaning the sensors.

SURETST COMM This indicates a loss of communication with the SureVend™ system. Check all harness connections between the main controller and the SureVend™ controller.

3. CONTINUE.



TEST THE DISPLAY

1. Press , then press  until the display shows *DSPLY TEST*.
2. Press  to light all display segments; press  to turn them off.
3. Pressing any key on the customer keypad will display that character in every segment.
4. CONTINUE.



**DOWNLOAD DATA TO A PDCD
(DEX Mode Only)**

1. Connect your portable data collection device (PDCD) per its operating instructions.
2. If data does not download into your PDCD upon connection, press . Data is downloaded into your PDCD.

NOTE

Depending upon the setting selected in "**Set DEX Options**" on page 57, data may be cleared after the download is complete.

3. CONTINUE.



SET FREEVEND OPTIONS

1. Press  until one of the following is displayed:

FREE OFF - Normal vending mode. No items are on freevend. A closure on the keyswitch input causes the machine to go out of service.

FREE ON - All items are on freevend. The credit display shows: *NO MONEY REQUIRED*. A closure on the keyswitch causes the machine to go out of service.

FREE W/KEY - All items are freevended while there is a closure on the keyswitch input. Normal cash sales are supported when the keyswitch input is open. If the free vend code (see "**Enter a Freevend Code**" on page 55) is not **0000**, the code must be entered first.

FREE DNCE - A closure on the keyswitch input causes only the next item to be freevended. Coin mechanism errors are ignored. Normal cash sales are also supported.

2. If *FREE W/KEY* is selected, press  to limit free vending to specific selections. Press the letter of the selection you want to vend. For example, the display shows **.A C - - - -*
- . Selections A and C will allow free vends.
3. CONTINUE.



VIEW DIAGNOSTIC MESSAGES

1. Press . the display shows any of the following diagnostic messages, depending upon any fault(s) present:

ERROR MESSAGES

<i>NO ERRORS</i>	None of the following errors are detected:
<i>AJPTMR XX.XM</i>	This appears if the SureVend™ anti-jackpot timer is active, showing the time remaining on the timer. This timer is cleared upon closure of the main service door.
<i>AJP XXX MN/DY HR.MM</i>	This shows the total number of times the SureVend™ anti-jackpot feature occurred plus the date and time of the last occurrence. Press  to reset this count.
<i>CARD.COMM</i>	Incomplete card reader communications. Check cables or replace unit.
<i>CARD.FCOMM</i>	Incomplete card reader communications - check cables. The card reader is not operational.
<i>CARD.ERR</i>	Card reader is indicating it has a problem.
<i>CARD.ERRXX</i>	Card reader has an error and indicates code XX. The code is defined by the card reader manufacturer. To correct, contact card reader manufacturer. The unit is still operational.
<i>CARD.FERR</i>	Card reader is indicating it has failed. Replace unit.
<i>CARD.FERRXX</i>	Card reader has failed and indicates code XX. The code is defined by the card reader manufacturer. To correct, contact card reader manufacturer.
<i>CARD.FJAM</i>	Card reader has failed because card is jammed in the unit. Remove the jammed card.
<i>CARD.SERV</i>	Card reader requires service. The unit is still operational.
<i>CHK PRICE</i>	Price error detected and changed to maximum - check prices.
<i>CHK CONFIG</i>	A PRODUCT CONFIG value was out of bounds and set to nominal - check all PRODUCT CONFIGs.
<i>DBV.ACCEPT</i>	The vending machine is telling the bill validator not to accept any bills. Check the enabled channels of the bill validator.
<i>DBV.COMM</i>	Incomplete bill validator communications -- check harness.
<i>DBV.JAM</i>	A bill is jammed in the acceptance path. The unit will disable itself until the error is corrected. Remove bill stuck in the acceptance path. Cycle machine power OFF and then ON.
<i>DBV.MOTOR</i>	One of the motors has failed. The unit will disable itself until the error is corrected. Check for bill stuck in the acceptance path. If no bill is present, replace the validator. Cycle machine power OFF and then ON.

ERROR MESSAGES (CONTINUED)

<i>DBV.ROM</i>	ROM checksum failure. The unit will disable itself until the error is corrected. Replace the validator.
<i>DBV.SENSOR</i>	One of the sensors in the bill validator has failed. The unit will disable itself until the error is corrected. Check for bill stuck in the acceptance path. If no bill is present, replace the validator. Cycle machine power OFF and then ON.
<i>DBV.STACKR</i>	The stacker is open or removed. The unit will disable itself until the error is corrected. Install the stacker correctly.
	The stacker is full of bills. Remove bills from the stacker.
<i>ERR A B C (ETC)</i>	Error exists on tray A, B, C, etc. Motor may be jammed, not home, or a couple error exists.
<i>FOOD 1.2.* TIMEOUT</i>	(The * is flashing.) Jammed door.
<i>FOOD 1.2.3. BOTH SW.2 +3.</i>	(The 2 is flashing.) Door seen as open and closed.
<i>FOOD 1.2.NO SHUT SW.3</i>	(The 3 position is flashing.) Could not find the closed position.
<i>FOOD 1.3.NO OPEN SW.2</i>	(The 2 position is flashing.) Could not find the open position.
<i>FOOD . 3. AUX.DR OPEN</i>	(The 1 position is flashing.) The loading door is open.
<i>FOOD 1 . NOT SHUT</i>	(The 3 position is flashing.) Not in the shut position.
<i>HC.ERR XX°F</i>	Refrigerated products went out of service on date-time MM/DD/YY HR.MN because of a health MM/DD/YY HR.MN control error. The maximum temperature reached after this time was XX°F.
<i>ONLY TOP 2 SHELVES AVAILABLE</i>	Refrigerated products went out of service on health control. Only trays A and B are available.
<i>ONLY TOP 3 SHELVES AVAILABLE</i>	Refrigerated products went out of service on health control. Only trays A, B, and C are available.
	One of the motor sensor lines is idling in an incorrect state. This error could indicate a bad interface board or a bad or pinched harness. Disconnect the harness and see if the error disappears. If so, the harness is to blame. If not, suspect the interface board.
<i>HOME.SMS XX</i>	<i>0X</i> - indicates an error in the snack matrix (section) <i>01</i> - indicates an error in the even home line <i>02</i> - indicates an error in the odd home line <i>03</i> - indicates an error in both odd and even home lines <i>X0</i> - indicates an error in the can unit (if available)
<i>KEYPAD XY</i>	Key(s) x, y stuck.
<i>KEYSWITCH</i>	This error is generated if the freevend key switch is on, but the machine is not configured with free w/ key.

ERROR MESSAGES (CONTINUED)

<i>MECH.ACCEPT</i>	Coin mechanism acceptor section is unplugged from the main body of the coin mech. Connect the cable and cycle machine power OFF and then ON.
<i>MECH.COMM</i>	The vending machine is telling the coin mech not to accept any coins
<i>MECH.JAM</i>	Incomplete coin mech communications -- check harness. One or more coin tubes are jammed. Pay a coin from each tube until the jam is cleared.
<i>MECH.ROM</i>	Coin is jammed in the acceptor section. Check the coin mechanism for a jam in this position. Insert coins and cycle machine power OFF and then ON.
<i>MECH.SENSOR</i>	Replace the coin mechanism.
<i>NO MECH</i>	Coin mech reporting a bad tube sensor - replace mech
<i>NONE READY</i>	Coin mech not detected - machine will not operate if configured for coin mech.
<i>RAM ERROR</i>	No selection is ready to vend. Check that no time-of-day inhibits are active. RAM is not initialized or is not compatible with the currently loaded software. If this message appears, initialize your RAM by performing the following procedure: NOTE: Initializing RAM will erase all your data. Be sure you have written this information down before continuing.
	Press AND HOLD  until you hear two beeps and the display shows <i>FINISHED</i> .
<i>ROM ERROR</i>	Error in the programming EPROM. MACHINE WILL NOT OPERATE.
<i>TEMP REF</i>	The temperature reference on the main pcb cannot be read. If the temp sensor reading has been invalid for 2 minutes and the temperature setpoint is below 54°F the compressor will run at a fixed 10 min on and 15 min off until the temperature becomes valid. If the setpoint is 54 °F or above the compressor will turn OFF and will remain off until the temp sensor becomes valid.
<i>TEMP SNSR</i>	The primary temperature sensor cannot be read.
<i>TEMP RANGE</i>	The primary temperature sensor is out of range.
<i>TEMP2 SNSR</i>	The secondary temperature sensor cannot be read.
<i>TEMP 2.RANGE</i>	The secondary temperature sensor is out of range.
<i>TEMP XX°F TOO COLD</i>	The monitored temperature is too cold. This error may occur if the compressor does not properly turn off when there is no period (".") following °F or °C or if the merchandiser configuration was recently changed to a warmer setpoint.

ERROR MESSAGES (CONTINUED)*SURE.EMPTY NN*

Selection NN was marked as empty by the SureVend™ system because a product delivery was not detected. This error is cleared upon closure of the main service door.

SURE.TST XX

This diagnostic automatically enters the appropriate SureVend™ test screen. See "**Test the SureVend™ System**" on page 89.

B		Mode Keys, Lock Or Unlock	56
Base Plate, Install	45	Monetary Option	
Bill Selection Method	59	ACC.STK	61
Bill Validator, Select	59	CHANGE X.XX	61
Bill Validator, Test	49	DECLINE.ON	62
C		FAIL = CASH	62
Card Reader Paid Sales, View	79	LOW.MSG	62
Card Reader, Setup	60	Monetary Options, Setup	61
Cash Box Lock, Install	46	Motor Harness, Connect	24
Coin Box Amount, View	81	Motor Harness, Disconnect	24
Coin Mechanism, Load	47	Motor, Remove	23
Coin Mechanism, Select	58	Motors, Test	87
Coin Mechanism, Setup	47	N	
Column Divider, Install	22	Nonresettable Sales Data, View	79
Column Divider, Remove	22	Nonresettable Vend Data, View	79
Coupon Sales, View	80	Non-standard Bill Validator, Setup	60
Custom Messages, Edit	76	O	
D		Operational Readiness Check	48
Date, Set	71	Out-of-service Message	75
Daylight Savings, Set	71	Overbuy Disabled	62
Declining Balance	62	P	
Defrost Options	68	Paid Sales Data, Clear	81
DEX Mode, Setup	57	Payout Coins	78
DEX Options, Set	57	Payout Keys, Lock Or Unlock	56
Diagnostic Messages, View	91	SureVend™ Data, View	86
Disable Trays	65	SureVend™, Test	89
Display, Test	90	Power Requirements	3
E		Price Labels, Install	38
Enable Trays	65	Price Roll, Adjust	39
End of Message Character	76	Prices, Set	78
Error Messages, View	91	Printer Baud Rate, Select	58
Escrow	61	Printer Mode, Select	57
F		Product Pusher	35
Forced Vend	61	Product Spacer, Install	32
Free Vends, View	82	Product Spacer, Remove	32
Freevend Code	55	R	
Freevend Message	75	Resettable Data, Clear	80
L		Revalue Option	60
Language, Select	58	S	
Lock Cylinder, Install	46	Sales Data, View	79
Lunch Buckets	35	Selection ID Numbers, Install	39
M		Set	
Machine Configuration	64	Defrost Options	68
Machine ID Number, View	85	Setup	
Machine Temperature, View	70	Bill Validator	59
Message		Card Reader	60
Out-of-service	75	Coin Mechanism	47
Standby	74	Date	71

Daylight Savings	71	Total Paid Vends, View	80
DEX Mode	57	Total Unpaid Sales, View	85
Freevend	90	Total Unpaid Vends, View	85
Machine Configuration	64	Tray Motors, Couple/Uncouple	67
Monetary Options	61	Tray, Install	31
Non-standard Bill Validator	60	Tray, Removal	19
SureVend Anti-Jackpot	66	Trays, Setup	18
Prices	78	U	
Talker Mode	56	Unscheduled Defrost	68
Three tray configuration version 1	13	V	
Time of Day	71	Vending Position	37
Trays	18	Verify Credit Added	87
Two or three tray configuration version 2 15		View	
Two tray configuration version 1	11	Amount in Coin Box	81
Winner Mode	63	Amount In Validator	81
Software Version, View	70	Card Reader Paid Sales	79
Spiral Bearing, Install	23	Coupon Sales	80
Spiral Coupler, Install	29	Diagnostic Messages	91
Spiral Coupler, Remove	26	Discount Sales By Time Interval	82
Spiral Indexing Procedure	48	Error Messages	91
Spiral Motor, Install	27	Free Vends	82
Spiral Motor, Remove	27	Freevend Sales By Time Interval	82
Spiral Options	25	Machine ID Number	85
Spiral Wall Retainer	34	Motor Status By Tray	88
Spiral, Install	25	Nonresettable Sales Data	79
Spiral, Remove	25	Nonresettable Vend Data	79
Standby Message	74	SureVend™ Data	86
Supervisor Code	55	Sales Data	79
Supervisor Code, default	55	Test Vends	85
Supervisor Mode	55	Time Data	83
T		Total Paid Vends	80
Talker Mode, Setup	56	Total Unpaid Sales	85
Temperature, Set	64	Total Unpaid Vends	85
Temperature, Show in Standby Mode	69	Winners	83
Test		View Surevend Software version	70
Display	90	W	
Motors	87	Wide Products	18
SureVend™	89	Winner Mode	63
Test Vend	87	Winners, View	83
Test Vends, View	85		
Time Data, View	83		
Time Interval Editing	72		
Time Of Day, Set	71		
Time-Of-Day Vending			
Discount	72		
Free	72		
Inhibited	72		
Top Shelf	36		

Terms and Conditions of Sale

LIMITED WARRANTY: Subject to the limitation specified herein, all parts included on original equipment manufactured by CRANE MERCHANDISING SYSTEMS and sold to purchaser are warranted for two (2) years from the date of shipment of the equipment in question. This warranty applies only to the original purchaser of the Merchandiser and is null and void if the Merchandiser is sold during the period of warranty.

Defective parts will be repaired or replaced free of charge when the defective part is returned, with transportation charges prepaid by purchaser, to a destination designated by CRANE MERCHANDISING SYSTEMS.

This warranty does not include any cost of service rendered or repairs made by customer or its agents on Merchandiser, or parts, unless authorization to incur such expense has been given in writing by CRANE MERCHANDISING SYSTEMS prior to incurring such expense. This warranty covers labor and service charges performed by CRANE MERCHANDISING SYSTEMS service technicians for the first 90 days of ownership from date of shipment.

This warranty does not apply to A) electrical components, wiring, or circuits or mechanical parts or assemblies damaged as a result of operating the Merchandiser at other than the design voltage and frequency specified on the Electrical Rating Tag, or B) in event of vandalism, fire or negligence, or C) incandescent lamps, neon lamps, fluorescent lamps, ballasts, starters or other expendable items, or D) when seal is broken on electronic boards, or E) when other manufactured components are installed in CRANE MERCHANDISING SYSTEMS Merchandisers.

Replacement parts sold by CRANE MERCHANDISING SYSTEMS as After Market shall be covered for three months from the date shown on the parts invoice. Purchaser must obtain prior RETURN AUTHORIZATION for return of all parts, following guidelines given by CRANE MERCHANDISING SYSTEMS. New, unused parts purchased as After Market can be returned within 30 days from date of parts invoice, with prior authorization from CRANE MERCHANDISING SYSTEMS.

THIS WARRANTY IS IN LIEU OF ALL OTHER WARRANTIES EXPRESS OR IMPLIED, INCLUDING WITHOUT LIMITATION, WARRANTIES OF MERCHANTABILITY OF FITNESS FOR A PARTICULAR PURPOSE. CRANE MERCHANDISING SYSTEMS SHALL NOT BE RESPONSIBLE FOR CONSEQUENTIAL OR PUNITIVE DAMAGES. CRANE MERCHANDISING SYSTEMS neither assumes nor authorizes any person to assume for it any obligation or liability in connection with the sale of said equipment or any part thereof.

