

Controller SII-D

P1 (Internal harness connection to "Power IN" Jack)

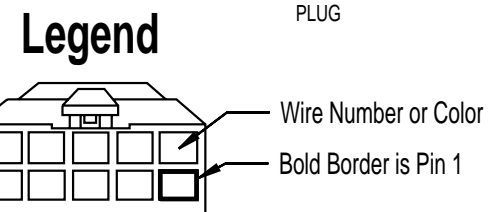
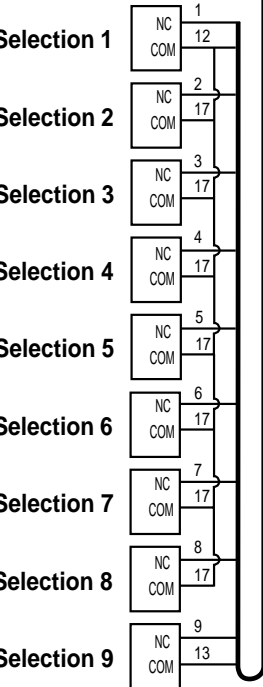
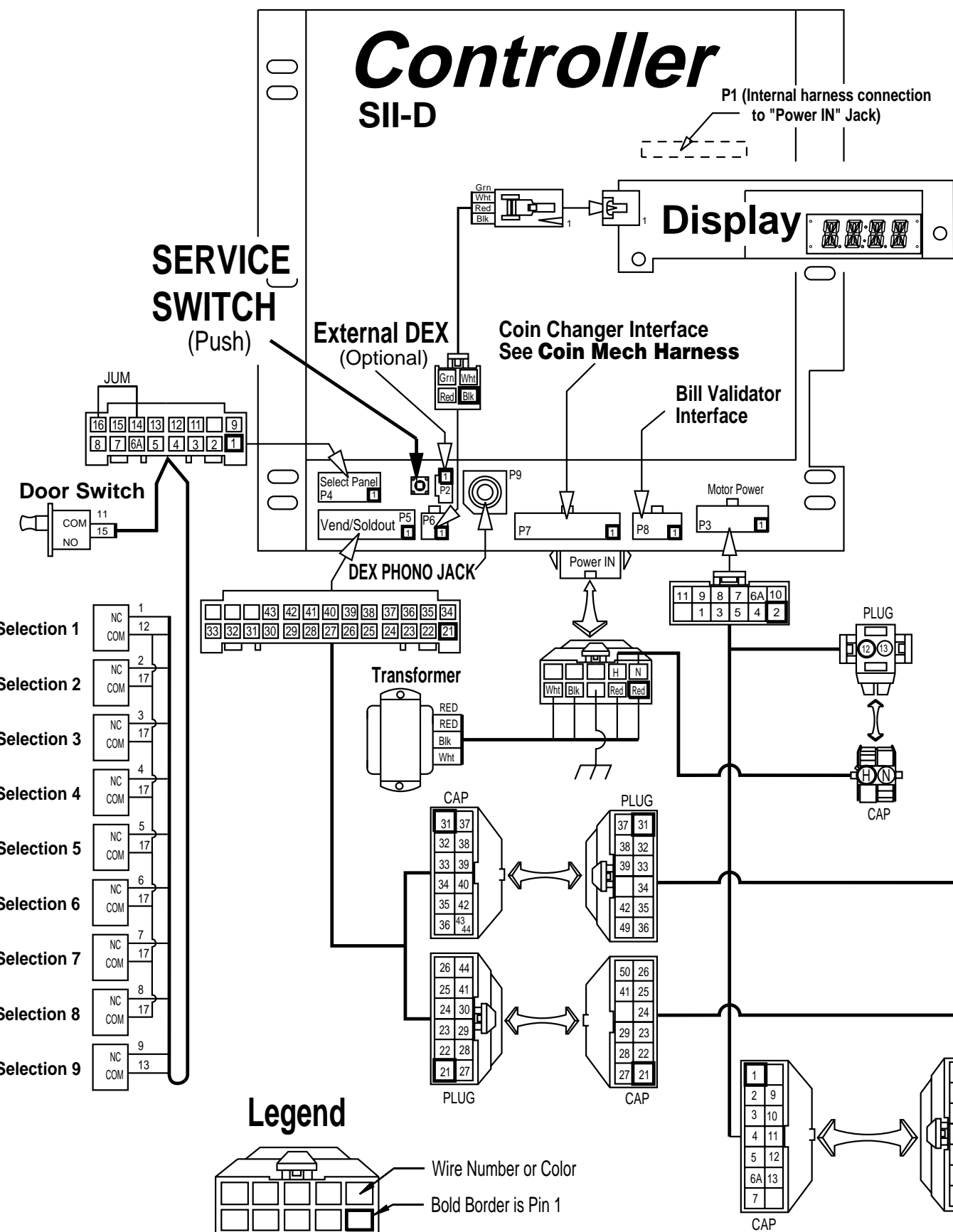

All Connectors are WIRE SIDE VIEW

Sold-Out Switches

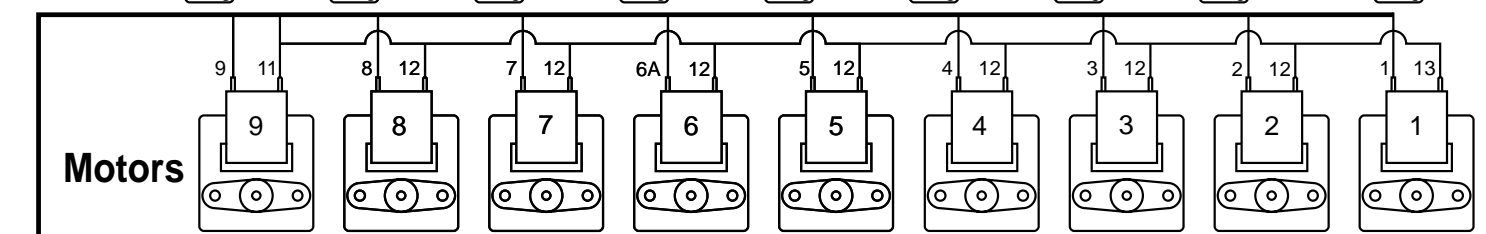

Motors

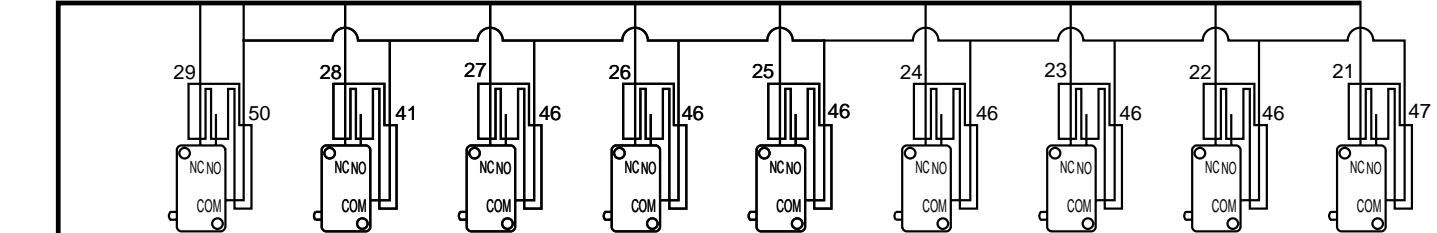

Vend Motor Switches

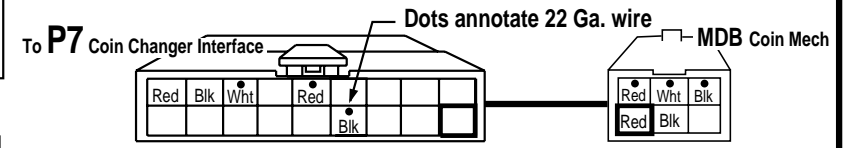
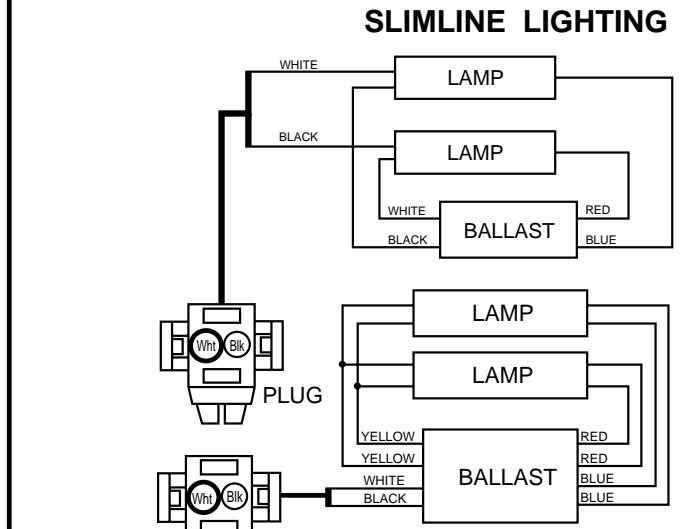

Coin Mech Harness

Dixie-Narco, INC.

**SII-D COKE
(9 Select) 501E/600E**

PATENT NOTICE
 This device is manufactured under one or more of the following United States Patents:
 4,298,138 4,264,000
 4,705,176 4,509,658

PRINTED IN U.S.A.
 DRAWING NO. 803,847,830.01

Stack Plug

