

Controller SII-D

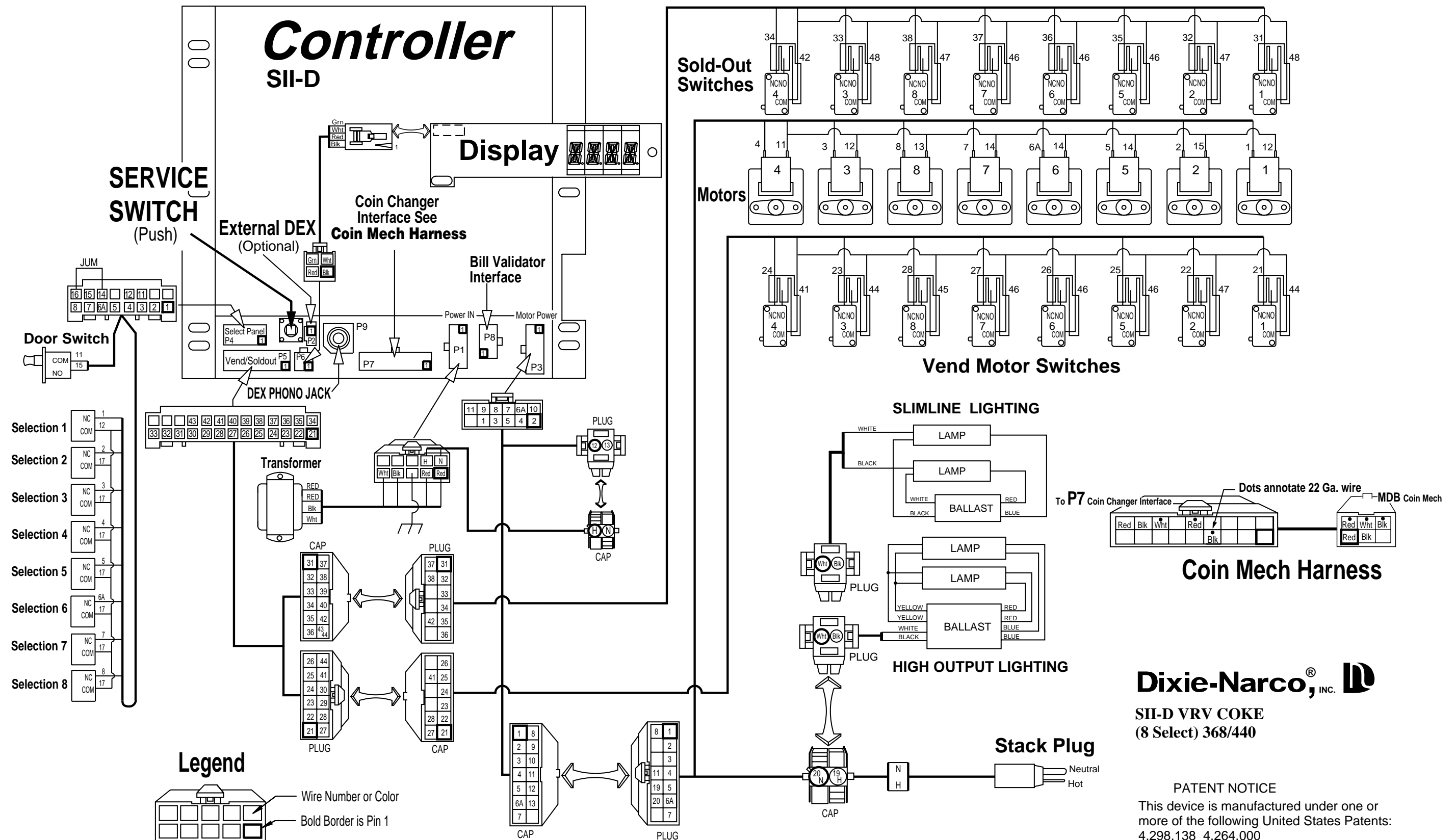

Legend

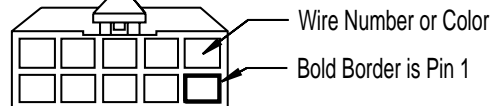

All Connectors are WIRE SIDE VIEW

Sold-Out Switches

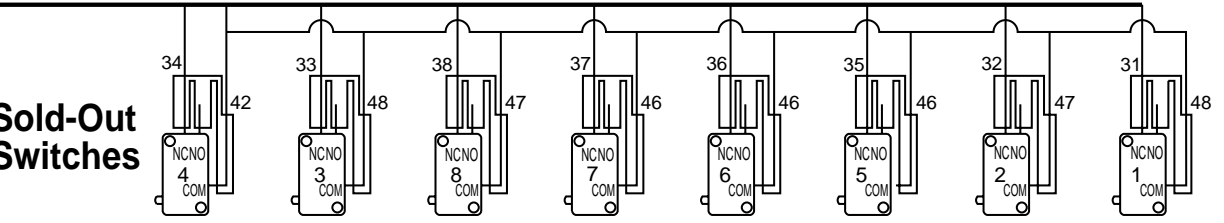

Motors

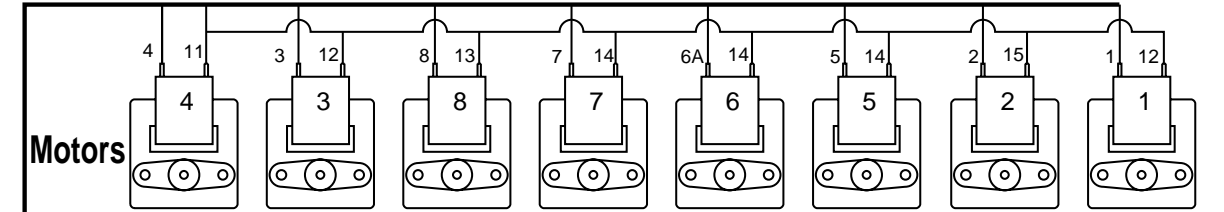

Vend Motor Switches

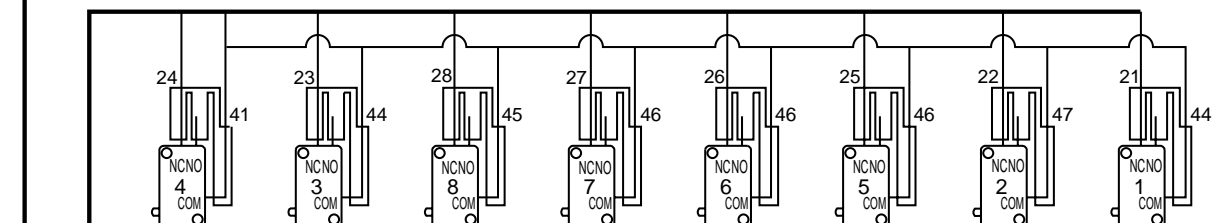

SLIMLINE LIGHTING

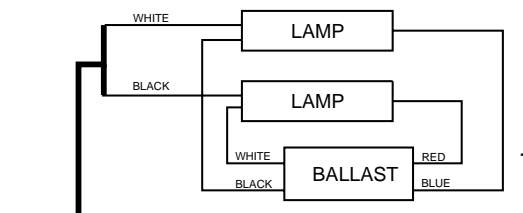

HIGH OUTPUT LIGHTING

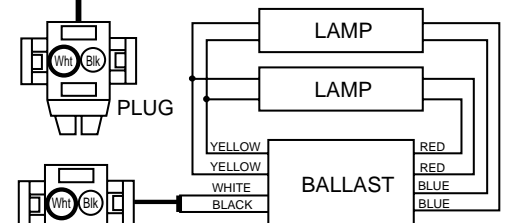

Stack Plug

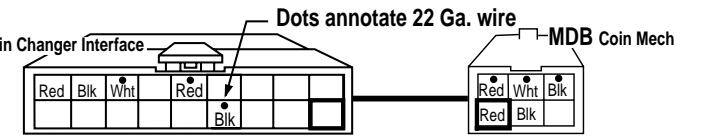
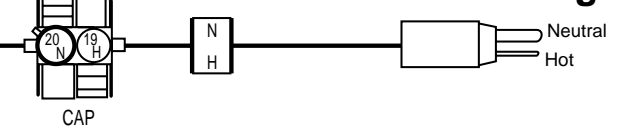

Coin Mech Harness

Dixie-Narco, INC.

SII-D VRV COKE
(8 Select) 368/440

PATENT NOTICE

This device is manufactured under one or more of the following United States Patents:
 4,298,138 4,264,000
 4,705,176 4,509,658

PRINTED IN U.S.A.
 DRAWING NO. 803,842,220.41